

# ***Baxter***

## **Hillrom Centrella**

MEDICAL-SURGICAL  
HOSPITAL BED



Includes optional patient safety applications available in select countries:

- Heart and Respiration Rate Monitoring System
- **Voalte** Nurse Call System
- **WatchCare** Incontinence Management System

## Instructions for Use

Product No. P7900

193587 REV 15



## QUICK VIEW LIST OF BED FEATURES

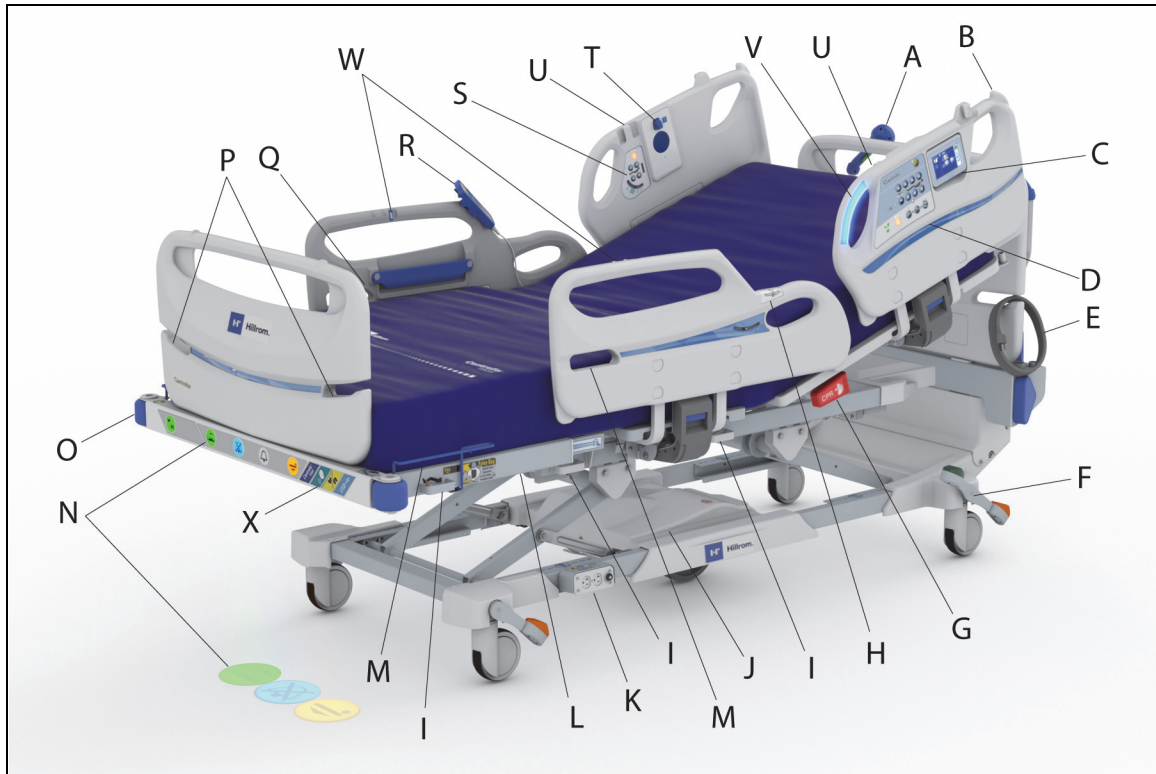

Item	Feature	Page	Item	Feature	Page
A	Transport/push handle (optional)	129	M	Drainage bag holder	18
B	Line Managers	24	N	<b>SafeView+</b> Alerts indicator with floor projections (optional)	26
C	<b>Graphical Caregiver Interface (GCI)</b> Control	44	O	Corner bumpers and equipment sockets	22
D	Caregiver control panel	33	P	Footboard cord storage	21
E	Headboard cord storage	21	Q	Patient storage area	26
F	Brake and steer control	19	R	Patient pendant (handheld remote) (optional)	39
G	CPR handle	17	S	Patient control panel	38
H	Patient Hip Position indicator	22	T	Speaker with optional USB charging port	25
I	Patient Restraint point	18	U	Patient pendant (handheld remote) holder	39
J	<b>IntelliDrive</b> Transport System (power transport—optional)	119	V	<b>IllumiGuide</b> Siderail Handgrip (siderail light—optional)	24
K	Auxiliary outlet (optional)	32	W	Urinal holder	25
L	<b>FlexAfoot</b> Retractable Foot Mechanism	49	X	Bed Feature label	8

**PATENTS / PATENT** [hillrom.com/patents](http://hillrom.com/patents)

May be covered by one or more patents. See the above Internet address.  
The Hill-Rom companies are the proprietors of European, US, and other patents and pending patent applications.

**FOSS**

This product may contain software known as “free” or “open source” software (FOSS). Hill-Rom uses and supports the use of FOSS. We believe that FOSS makes our products more robust and secure, and gives us and our customers greater flexibility. To learn more about FOSS that may be used in this product, please visit our FOSS website at [hillrom.com/opensource](http://hillrom.com/opensource). Where required, a copy of FOSS source code is available on our FOSS website.

**Legal Manufacturer:**

HILL-ROM, INC.  
1069 STATE ROUTE 46 E  
BATESVILLE, IN 47006-9167 USA

**Authorized European Union Representative  
and EU Importer:**

HILL-ROM SAS  
B.P. 14 - Z.I. DU TALHOUE  
56330 PLUVIGNER  
FRANCE  
TEL: +33 (0)2 97 50 92 12

**Authorized Australian Sponsor:**

HILL-ROM PTY LTD  
1 BAXTER DRIVE  
OLD TOONGABBY NSW 2146  
TEL: 1800 650 083

No part of this text shall be reproduced or transmitted in any form or by any means, electronic or mechanical, including photocopying, recording, or by any information or retrieval system without written permission from Hill-Rom Services, Inc. (Hill-Rom).

The information in this manual is confidential and may not be disclosed to third parties without the prior written consent of Hill-Rom.

The information in this manual is subject to change without notice. Hill-Rom makes no commitment to update or keep current the information in this manual.

Hill-Rom reserves the right to make changes without notice in design, specifications, and models. The only warranty Hill-Rom makes is the express written warranty extended on the sale or rental of its products.

**Notice to Users and/or Patients in EU**—Any serious incident that has occurred in relation to this device should be reported to the manufacturer and the competent authority of the Member State in which the user and/or patient is established.

This manual (193587) was originally released and supplied in English. For a list of available translations, contact Hill-Rom Technical Support.

Product images and labels are for illustrative purposes only. Actual product and label may vary.

Fifteenth Edition, 2023-02

First Printing, 2017

Bluetooth is a trademark of Bluetooth Sig, Inc.

CSA is a trademark of Canadian Standards Association, Inc.

Clorox Healthcare is a trademark of The Clorox Professional Products Company, Inc.

Oxivir TB and Virex are trademarks of DIVERSEY, Inc.

Oxycide is a trademark of EcoLab USA, Inc.

Wex-Cide is a trademark of Wexford Labs, Inc.

The UL logo is a trademark of Underwriter's Laboratories, Inc.

Baxter, Auto Contour, Boost, Centrella, Dining Chair, Experience Pod, FlexAfoot, Graphical Caregiver Interface (GCI), Hillrom, IllumiGuide, IntelliDrive, Line-of-Site, Microclimate Management MCM, Obstacle Detect, Point-Of-Care, Quick View, ReadyConnect, SafeView, SideCom, SmartSync, Voalte, WallGuard and WatchCare are trademarks of Baxter International Inc. or its subsidiaries.

Replace this manual (193587) if it is damaged and/or cannot be read.

For product support or to order additional copies of this manual (193587), contact your distributor, local Hill-Rom representative, or go to [hillrom.com](http://hillrom.com).

### **Reference Documents**

**Centrella** *Smart+ Bed Service Manual* (193588)

**Centrella** *Smart+ Bed Unpacking Instructions* (193589)

**WatchCare** *User and Service Manual* (196414)

*pro+ Mattress Instructions for Use* (209196)

*pro+ Mattress Service Manual* (209197)

**Hillrom ReadyConnect** *System Instructions for Use and Service Manual* (217064)

**Hillrom ReadyConnect** *System Wall Module Installation* (216777)

**NOTES:**

---

# Table of Contents

Quick View List of Bed Features .....	i
Intended Use .....	1
Introduction.....	1
Safety Information.....	1
Symbols.....	4
Product Symbols .....	4
Caregiver Control Panel .....	5
Graphical Caregiver Interface (GCI) Control (Touchscreen) .....	6
Other Touchscreen Symbols.....	7
Foot End Feature Label .....	8
Patient Pendant (Handheld Remote) Option .....	9
Siderails.....	9
Bed Frame .....	9
Foot-End SafeView+ Alerts Option .....	11
Experience Pod (overhead arm) Device Option .....	12
Other .....	12
Alarm, Alerts, and Information Indicators .....	13
Low Priority Alarm.....	13
Beep Alerts.....	13
Verbal Alerts .....	14
Bed Exit Indicator.....	14
Alert Silence Indicator .....	14
Brake Not Set Alert .....	14
Service Required Indicator .....	14
Bed in Lowest Position Indicator .....	14
Battery Charging Indicators and Battery Backup .....	15
Bed Frame Battery Backup.....	15
Powered Transport Battery Charge Indicator .....	16
Bed Frame Features .....	17
CPR Control .....	17
Use the CPR Control .....	17
Patient Restraints and Drainage Bag Holders .....	18

Patient Restraints .....	18
Drainage Bag Holders .....	18
Power Cord .....	19
Cord Holders .....	19
Brake and Steer Controls .....	19
Headboard .....	21
Footboard .....	21
Equipment Sockets .....	22
WallGuard Bumper System .....	22
Hip Position Locator .....	22
Line-of-Site Angle Indicators .....	22
Head and Intermediate Siderails .....	23
IllumiGuide Siderail Handgrip Option .....	24
Light Status .....	24
Line Manager .....	24
USB Charging Port .....	25
Urinal Holder .....	25
Patient Storage .....	26
Motion Activated Night Light .....	26
SafeView+ Alerts Option .....	26
SafeView+ Alerts Indicators Status .....	26
Experience Pod Device (Overhead Arm) (P7926A and P7926A07) Option .....	28
Auxiliary Outlet Option .....	32
Point-Of-Care Bed Controls .....	32
Caregiver Bed Controls .....	33
Bed Exit Alert System .....	33
Lockout .....	34
Bed Up/Down .....	35
Obstacle Detect System .....	35
Head Up/Down .....	36
Knee Up/Down .....	36
Foot Up/Down .....	36
Trendelenburg and Reverse Trendelenburg .....	37
Boost Position System .....	37
Patient Controls .....	38



Nurse Call Control .....	38
Head Up/Down .....	39
Knee Up/Down.....	39
Auto Contour Feature .....	39
Patient Pendant (Handheld Remote) .....	39
SideCom Communication System.....	41
Nurse Call Control .....	41
Wireless Connectivity Option .....	42
Wireless and Bed Location Indicators on the Touchscreen .....	42
Wireless Status.....	42
Bed Location.....	43
Asset Tag .....	43
Hillrom ReadyConnect System .....	43
Voalte Nurse Call System .....	43
WatchCare Incontinence Management System .....	44
SmartCare Remote Management .....	44
Graphical Caregiver Interface (GCI) Controls .....	44
Use the Touchscreen Menu Controls .....	46
Help (?) Menu .....	47
Head Angle <30° Limit.....	47
Dining Chair Position .....	48
Stand Assist .....	48
Bed Flat.....	49
FlexAfoot Bed Length Adjustment .....	49
Bed Exit Alert System .....	49
Bed Exit Mode Descriptions.....	49
To Silence the Bed Exit Alert without Deactivating the System .....	51
Scale.....	52
Scale "A" .....	52
To Zero the Scale.....	53
Required Bed Position to Zero the Scale.....	53
New Patient (Zero) .....	54
Re-Zero (Same Patient) .....	55
To Weigh the Patient .....	56
Required Bed Position to Weigh the Patient.....	56

Scale “A” Specifications .....	58
Scale “B”—NAWI Compliant (EN 45501) .....	58
To Zero/Tare the Scale.....	59
Required Bed Position to Zero the Scale.....	59
Zero (New Patient) .....	60
Re-Zero (Same Patient) .....	62
+/- (Change Zero Items) .....	63
To Weigh the Patient .....	64
Optimum Bed Position to Weigh the Patient .....	64
Scale “B” Specifications .....	66
To Troubleshoot Scale Messages.....	66
Settings/Preferences .....	68
Software Update .....	68
SafeView+ Alerts Floor Projections Option—ON/OFF .....	68
IllumiGuide Siderail Handgrip (blue light only)—ON/OFF .....	69
Siderail Protocol.....	70
USB Charging Port—On/Off .....	70
Voice Alerts .....	71
Mattress Features .....	72
Screen Brightness .....	73
Foley Position Limit .....	74
Bedside Association .....	74
Set Up the Bed Association through the Settings Menu .....	75
Set Up the Bed Association Using the Room/Patient Icon .....	77
Associate a Room to the Bed.....	77
Verify the Patient Identity.....	78
Confirm the Room to Bed Association.....	78
Override the Room to Bed Association .....	78
Verify the Patient Identity when Zeroing the Scale.....	79
New Patient Assignment and Bedside Association.....	80
Weighing and Bedside Association.....	80
HR/RR Monitoring and Bedside Association .....	81
Bedside Association Notes: .....	82
Heart and Respiration Rate Monitoring System .....	83
Intended Use .....	83

Symbols .....	83
Document Symbols .....	83
Product Symbols .....	84
GCI Symbols—HR/RR Monitoring System .....	85
HR/RR Monitoring System Specification .....	85
HR and RR Monitoring System Information .....	85
Introduction .....	88
Alarm, Alerts, and Information Indicators.....	89
Low Priority Alarm.....	89
Low Priority Alarm Parameters (HR/RR Monitoring System) .....	89
Beep Alerts.....	89
Activate the Trial Mode.....	90
Activate the Licensed Mode .....	92
Reset HR and RR Data.....	93
Turn ON/OFF HR and RR Display .....	95
HR and RR Trends Screen .....	96
To View HR and RR Trends .....	97
Change HR and RR Alarm Thresholds.....	97
Alarms .....	98
Turn On/Off In-Room Alarms .....	100
Turn On/Off Remote Alarms .....	101
Change HR and RR Alarm Volume.....	101
View HR/RR Alarm Log.....	102
Turn ON/OFF HR and RR Monitoring .....	102
View Sensor Expiration Information .....	103
HR/RR Monitor Activated Label Option.....	104
Voalte Nurse Call System—HR/RR Monitoring .....	104
Hillrom Digital Health Gateway—HR/RR Monitoring .....	104
Mattress Information .....	104
Modes .....	105
Normal .....	105
Max Inflate.....	106
Patient Comfort .....	107
To Adjust the Firmness .....	107

To Turn On/Off the Patient Comfort Controls on the Patient Pendant (Handheld Remote) .....	107
pro+ Mattress .....	108
Turn Assist .....	109
Continuous Lateral Rotation (CLR) .....	110
Setup .....	112
Rotation Preview .....	112
Start Rotation .....	113
Rotation History .....	114
Stop Rotation .....	114
Mattress Removal .....	115
Transport The Patient .....	116
Transport Safety Information .....	116
Prepare the Bed for Transport .....	118
To Transport .....	118
Use the Powered Transport System .....	119
Power Loss during Transport .....	120
After Transport .....	120
Accessories .....	121
Line Managers (P7512) .....	121
IV Poles (P2217 and P7511) .....	121
Removable IV Pole (P2217) .....	122
Permanent IV Pole (P7511) .....	122
Infusion Support System (P158) .....	122
Transport Shelf (7524) .....	123
Oxygen Tank Holder, E-Size (P276A) HX or F-Size (P009408) Patient Helper (P7934 or P7936) .....	124
Patient Helper Bracket Support (P7928) and Patient Helper Sleeve (P3212) .....	127
Patient Helper Bracket Support (P7938) and Patient Helper Sleeve (P3212) .....	128
Patient Helper Bracket Support (P7938) and HD Patient Helper Mount (P7939) .....	128
Traction Frame (P7927 or P7937) .....	128
Push Handles Option .....	129
Cleaning and Disinfecting .....	129
Recommendations .....	130
Cleaning and Disinfection .....	130

Prepare the Bed for Cleaning and Disinfecting.....	131
STEP 1: Cleaning .....	131
STEP 2: Disinfection .....	134
Prepare the Bed for Use .....	134
Laundry Guidelines.....	134
Preventive Maintenance .....	135
Batteries .....	136
Bed Frame .....	136
IntelliDrive Transport System .....	136
Decommissioning and Disposal Instructions.....	137
Service Calls.....	137
Troubleshooting .....	138
Power Loss.....	138
The Bed Does Not Lower.....	138
Specifications .....	139
General Wireless Recommendations .....	146
Wireless Connectivity Specifications .....	147
Standards.....	147
Encryption.....	147
Extensible Authentication Protocol Types (EAP Types).....	147
Wireless System Characteristics .....	148
WiFi and Bluetooth Radio Approval .....	148
Regulatory Information.....	148
USA—Federal Communications Commission (FCC) Radiation Exposure Statement ....	149
Interference Statement for FCC .....	149
Canada—Industry Canada (IC).....	149
Department Identification Label Placement .....	151

**NOTES:**

---

---

## INTENDED USE

The **Centrella** Smart+ Bed is intended for use in healthcare environments as a patient support system to prevent and/or treat pressure injuries. It is intended for a broad patient population as determined appropriate by the caregiver or institution. It is intended for patient populations weighing at least 70 lb (32 kg) and is capable of supporting patients up to 500 lb (227 kg). The **Centrella** Smart+ Bed is intended to assist clinical staff by relaying bed data to hospital communication systems for display and monitoring.

For the Intended Use of the Heart and Respiration Rate Monitoring System (HR and RR Monitoring System), see “Intended Use” on page 83.

---

## INTRODUCTION

The **Centrella** Smart+ Bed is a patient support platform that helps improve patient safety and satisfaction.

This manual contains information necessary for the normal operation of the **Centrella** Smart+ Bed and **Centrella** Mattresses from Hill-Rom. Before you operate the bed, make sure that you read and understand in detail the contents of this manual. It is important that you read and strictly obey the aspects of safety contained in this manual.

Any reference to a side of the bed is from the patient’s view lying in the bed on his or her back.

The bed is equipped with a scale intended to weigh the patient in the bed.

To identify which revision of bed you have, look at the serial number label. The label is on the right side of the upper frame at the head end of the bed.

The letter that follows P7900 identifies the bed revision.

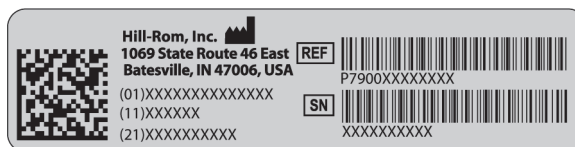

### NOTES:

- Throughout this manual the wall outlet for electric AC power (mains power), we identify as AC power.
- Beds with the HR and RR Monitoring System are equipped with a sensor under the mattress on the head section. Contact your local Hill-Rom representative for more information.

---

## SAFETY INFORMATION



### CONTRAINDICATION:

**Contraindication**—Use of active therapy surfaces (mattresses) with patients with unstabilized spinal cord injury could cause serious injury to the patient.



### WARNING:

Obey all **warnings** throughout the manual. Failure to do so could cause injury and/or equipment damage:

- **Warning**—Read and understand all **warnings** in this manual and on the unit itself prior to use with a patient.

**WARNING:**

(Warnings continued) Obey all **warnings** throughout the manual. Failure to do so could cause injury and/or equipment damage:

- **Warning**—Follow the product manufacturer’s instructions.
- **Warning**—The **Centrella** Smart+ Bed with or without the Heart and Respiration Rate Monitoring System, has an intended patient range of 70 lb (32 kg) to 500 lb (227 kg). Use of the bed with patients outside the intended patient weight range may increase the risk of entrapment, asphyxiation, and/or loss of therapeutic value. Use of the bed with patients above the bed’s intended maximum patient weight may also cause damage to the bed.
- **Warning**—Evaluate patients for entrapment and fall risk according to facility protocol, and/or healthcare provider directives, and monitor patients appropriately. Make sure all siderails are fully latched when in the raised position. Failure to do either of these could cause serious injury or death.
- **Warning**—The potential for electrical shock exists with electrical equipment. Failure to follow facility protocols may cause death or serious injury.
- **Warning**—To avoid risk of electric shock, this equipment must only be connected to a supply mains with protective earth.
- **Warning**—Make sure to use a correctly grounded, three-prong, 120 V outlet (NEMA 5-15R or NEMA 5-200R outlet, rated 125 V AC, 15 A or 125 V AC, 20 A, respectively). Failure to do so could cause personal injury, fire, or damage to the equipment or facility wiring.
- **Warning**—To help prevent the risk of hospital bed fires, make sure facility persons follow the safety tips in the *FDA Public Health Notification: Safety Tips for Preventing Hospital Bed Fires*. (US only)
- **Warning**—Connect the power cord to hospital grade receptacles only.
- **Warning**—Incorrect use or handling of the power cord may cause damage to the power cord. If damage has occurred to the power cord or any of its components, immediately remove the bed from service, and contact Hill-Rom.
- **Warning**—Do not use a power cord with a transparent plug. This will cause the inability to establish a connection over **Bluetooth** and also the wireless nurse call.
- **Warning**—The **Centrella** Smart+ bed has been tested to multiple safety standards (IEC 60601-1, IEC 60601-2-52 etc.). The use of non **Hillrom** approved components (including power cords) may impact the validity of safety standard reports for the bed.
- **Warning**—Take care to minimize the risk of tripping over the power cord by carefully locating it from the unit to its power source.
- **Warning**—Make sure the position of the unit is such that you can quickly, without obstruction, unplug the power cord from the main power supply if necessary.
- **Warning**—Do not use the bed in an oxygen rich environment or with oxygen tents.
- **Warning**—Do not operate the bed in the presence of flammable gas or vapors.
- **Warning**—Do not operate the bed in the presence of flammable anesthetics or nitrous oxide.
- **Warning**—Before maintenance or service is done on the unit, make sure to unplug the unit and remove the patient or fully remove the unit from use.
- **Warning**—Make sure that there are no foreign objects in the patient zone of the unit.
- **Warning**—If the cushions appear too firm or too soft after you use the Patient Comfort Adjustment controls, contact Hill-Rom.
- **Warning**—Air pressure in the **Centrella** max mattress is controlled automatically and may adjust without notice. Use care when you perform medical procedures on the patient.



**WARNING:**

(Warnings continued) Obey all **warnings** throughout the manual. Failure to do so could cause injury and/or equipment damage:

- **Warning**—Only use an approved Hillrom mattress on the **Centrella** Smart+ Bed or a risk of patient entrapment could occur.
- **Warning**—Use only Hillrom specified mattresses, parts, and accessories. Do not modify the bed system without authorization from Hill-Rom.
- **Warning**—Do not transfer the patient from one bed frame to another using the mattress with a patient on it.
- **Warning**—Use a minimum of two caregivers to transfer a patient on to the mattress.
- **Warning**—When you put a patient on to the mattress, make sure that the opposite siderails are raised or that another caregiver is present on the opposite side.
- **Warning**—Operate the bed within the stated environmental conditions; see “Environmental Conditions for Use” on page 140.
- **Warning**—The device is not compatible for use in Magnetic Resonance Imaging (MRI). Transfer the patient to a compatible surface to do an MRI and remove the bed from the MRI room.
- **Warning**—If the battery backup does not operate correctly (the bed does not articulate when you press an articulation control), plug the bed into AC power so that you can use the bed controls if necessary.
- **Warning**—Do not connect the power cord to an extension cord or multiple outlet strip. There is a risk of overheating and fire may cause injury or damage.
- **Warning**—Connect only items that have been specified as parts of the device or compatible with the device.
- **Warning**—Report to bed authorized maintenance persons any unusual sounds, burning odors, or movement deviations observed in the controls, motors, or limit switch functions.
- **Warning**—Consult your local regulations to safely discard or recycle electronic equipment and batteries.
- **Warning**—Do not discard as unsorted municipal waste. See your local distributor for collection and/or recycling system available in your country.
- **Warning**—This product can expose you to chemicals including Lead and Di(2-ethylhexyl) phthalate (DEHP), which are known to the State of California to cause cancer, and Lead and Di(2-ethylhexyl) phthalate (DEHP), which are known to the State of California to cause birth defects or other reproductive harm. For more information go to [www.P65Warnings.ca.gov](http://www.P65Warnings.ca.gov).
- **Warning**—The bed should be left in the lowest position when the patient is unattended.
- **Warning**—Federal USA law restricts this device to sale by or on the order of a physician.
- **Warning**—Make sure patient hands are kept away from moving parts while operating the bed.



**CAUTION:**

Obey all **cautions** throughout the manual and also the safety information below. Failure to do so could cause equipment damage:

- **Caution**—Do not store anything under the bed.
- **Caution**—Use only parts and accessories from Hill-Rom. Do not modify or change the bed system without approval from Hill-Rom.

**NOTE:**

The safety information for the HR and RR Monitoring System is on page 85.

---

## SYMBOLS

This instructions for use contains different typefaces and symbols to make the content easier to read and understand:

- Standard text—used for regular data.
- **Boldface text**—emphasizes a word, phrase, or trademarks.
- **NOTE:**—sets apart special data or important instruction clarification.
- CONTRAINDICATION, WARNING, or CAUTION



- A CONTRAINDICATION identifies situations or actions that may have an effect on patient safety.
- A WARNING identifies situations or actions that may have an effect on patient or user safety. To ignore a warning could cause patient or user injury.
- A CAUTION identifies special procedures or precautions that persons must obey to help prevent equipment damage.

## PRODUCT SYMBOLS

These symbols **may or may not** be on your configuration of the bed.

For more information about a feature, go to the page number shown for the feature in the tables below.

**NOTE:**

For product symbols for the pro+ mattress, see the *pro+ Mattress Instructions for Use (209196)*.

## Caregiver Control Panel

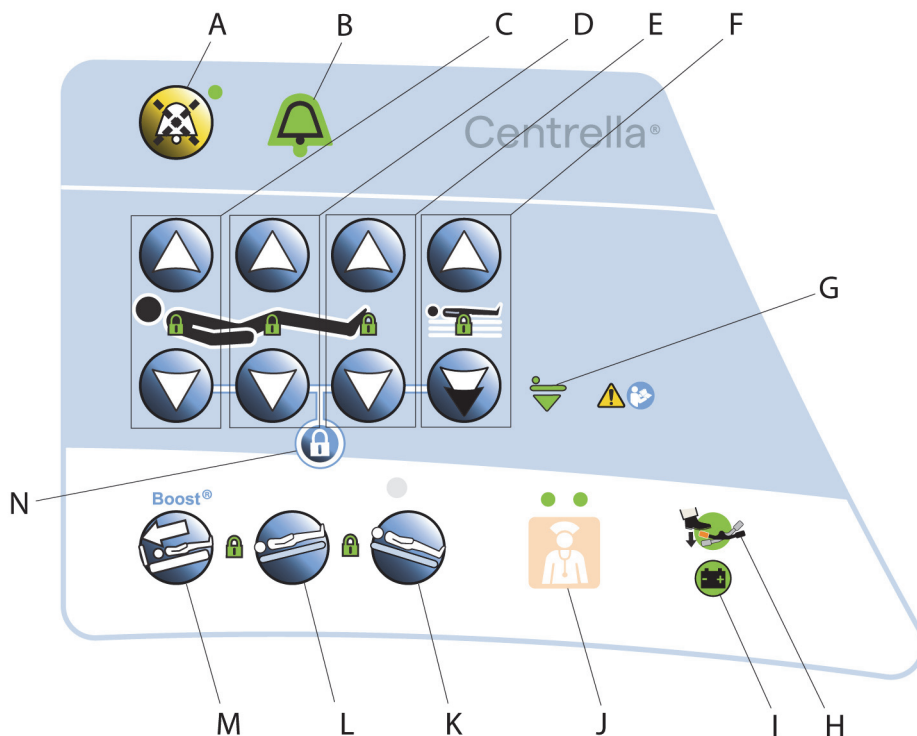





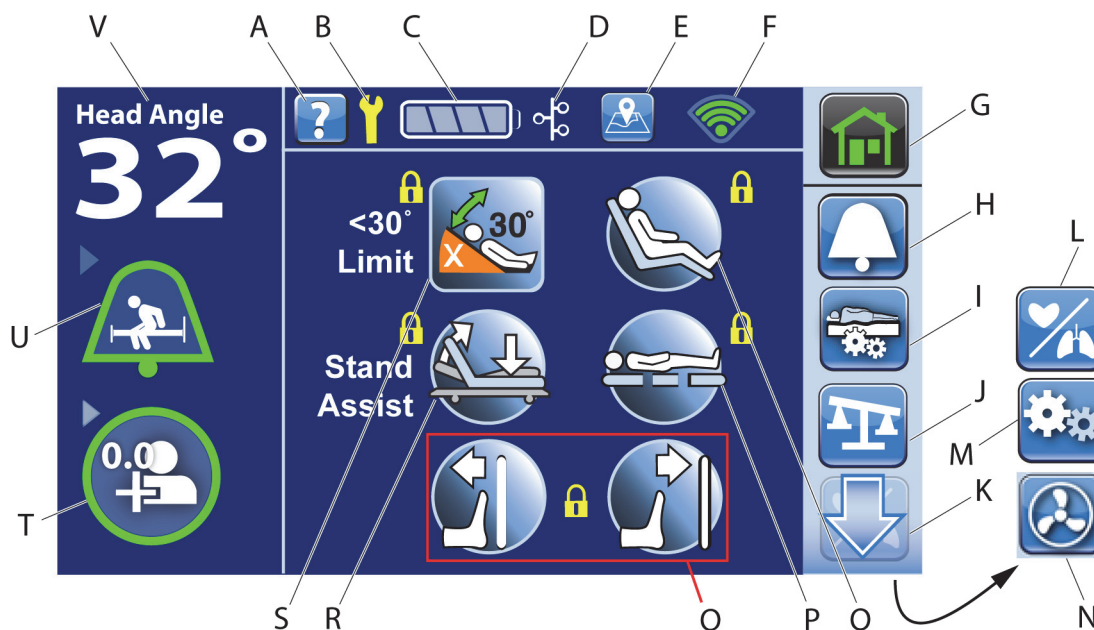















Item	Description	Page	Item	Description	Page
A	Alert silence control with LED indicator	14	H	Set brake indicator	14
B	Bed Exit Alert ON indicator	14	I	Battery charging indicator	15
C	Head up and down controls with lockout indicator	36	J	Nurse call control with LED indicators	41
D	Knee up and down controls with lockout indicator	36	K	Reverse Trendelenburg control with lockout indicator	37
E	Foot up and down controls with lockout indicator	36	L	Trendelenburg control with lockout indicator	37
F	Bed up and down controls with lockout indicator	35	M	<b>Boost</b> Position control	37
G	Bed in the lowest position indicator	14	N	Lockout control—locks out bed articulation controls	34











## Graphical Caregiver Interface (GCI) Control (Touchscreen)



Item	Description	Page	Item	Description	Page
A	Help (?) control	46	L	HR/RR Menu control	85
B	Service required indicator	14	M	Settings/Preferences Menu control	68
C	Bed battery charge indicator	15	N	<b>MCM</b> control (only on beds with a pro+ mattress)	108
D	<b>Voalte</b> Nurse Call System Connection (optional)	104	O	Chair control	48
E	Location control (optional)	43	P	Bed Flat and level control	49
F	WiFi indicator	42	Q	<b>FlexAfoot</b> bed length adjustment control	49
G	Home Menu control	45	R	Stand Assist control	48
H	Alerts Menu control	13	S	<30° Limit control	47
I	Mattress Menu control (only on beds with a <b>Centrella</b> max mattress)	104	T	Ready for New Patient indicator	55
J	Scale Menu control	52	U	Bed Exit Alert Status indicator	49
K	Down (and up) arrow control	46	V	Head Angle display	22

## Other Touchscreen Symbols

Symbol	Description	Page	Symbol	Description	Page
	Position Mode Bed Exit Alert—ON indicator	49		Turn Assist—patient right indicator	109
	Exiting Mode Bed Exit Alert—ON indicator	49		Turn Assist—patient left indicator	109
	Out of Bed Mode Bed Exit Alert—ON indicator	49		Max Inflate status indicator (only on <b>Centrella</b> max mattress)	106
	Bed Exit Alert system—OFF indicator	50		Adjust Bed Button control (for zero scale)	53
	Position Mode Bed Exit Alert—SILENCED indicator	51		Adjust Bed Button control (for weigh patient and turn assist)	55
	Exiting Mode Bed Exit Alert—SILENCED indicator	51		Hold to Adjust control (for weigh patient with a NAWI compliant scale)	59
	Out of Bed Mode Bed Exit Alert—SILENCED indicator	51		Not In Optimum Position when patient was weighed	55
	<b>Voalte</b> Nurse Call System Patient Safety Monitoring—SUSPENDED indicator	41		Foley Limit status—ON	74
	<b>Voalte</b> Nurse Call System Patient Safety Monitoring—ON indicator	41		Foley Limit status—OFF	74
	WiFi—signal strength indicator	42		Bed Location control—bed located	43
	WiFi—bed equipped with WiFi, but no WiFi Signal found indicator	42		Bed Location indicator—control is active to show the bed's location	43
	+/- Control (Add/Remove Items)	63		<b>MCM</b> —ON indicator for beds equipped with the pro+ mattress (integrated)	108

Symbol	Description	Page	Symbol	Description	Page
	<b>MCM</b> —OFF indicator for beds equipped with the pro+ mattress (integrated)	108		Room associated indicator (home and status screens)—beds with Bedside Association	74
	WiFi connected indicator—beds with Bedside Association	74		Room associated indicator (bed/patient locate screen)—beds with Bedside Association	74
	WiFi connecting indicator (flashing)—beds with Bedside Association	74		Room not associated indicator (bed/patient locate screen)—beds with Bedside Association	74
	Network connected indicator—beds with Bedside Association	74		Patient identity verified indicator—beds with Bedside Association	74
	Network connecting indicator (flashing)—beds with Bedside Association	74		Patient identity is not verified indicator. When flashing, a patient is assigned, but not verified, or the bed has rejected the patient identity—beds with Bedside Association	74
	Network not connected indicator—beds with Bedside Association	74			
<b>NOTE:</b> For symbol identification for the HR and RR Monitoring System option, see page 85.					

### Foot End Feature Label

The foot end feature label is on the base frame at the foot end of the bed. This label allows hospital staff to identify specific features the bed is equipped with. The label may have fewer or more of the features shown below:





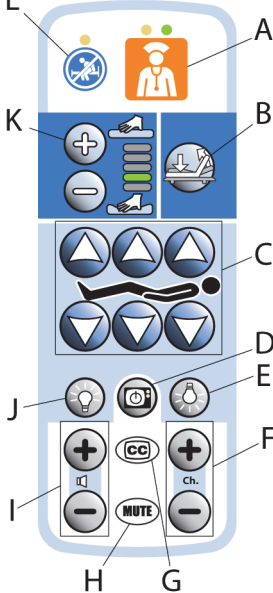

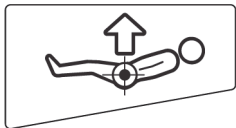
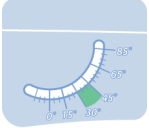

### Patient Pendant (Handheld Remote) Option

	Item	Description	Page
	A	Nurse call control with LED indicators	39
	B	Stand Assist control	
	C	Head, knee, and foot up/down controls	
	D	TV power control	
	E	Reading light control	
	F	Channel up and down control	
	G	Closed caption control	
	H	Mute control	
	I	Volume up and down control	
	J	Ambient light control	
	K	Comfort adjust pressure increase and decrease controls with indicators (only on beds with a <b>Centrella</b> max mattress)	
	L	Stay in Bed indicator	









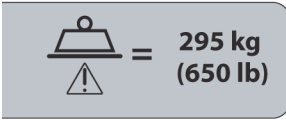

**NOTE:**



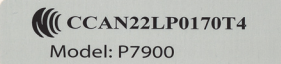
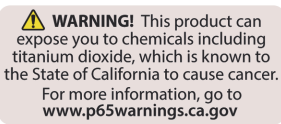





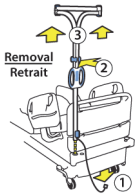
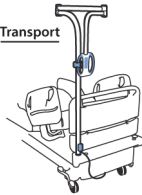
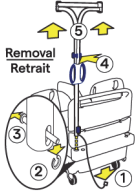

A patient can visit <https://yourbed.hill-rom.com> to learn more about this bed.







Symbol	Description	Symbol	Description
<b>Siderails</b>			
	Hip Position Locator (page 22)		Head angle (page 22)
	Trendelenburg/Reverse Trendelenburg angle (page 22)		USB charging port (page 25)
<b>Bed Frame</b>			
	<b>CPR</b> control label for the <b>bed frame</b> — shows how to operate the CPR control to lower the head section (page 17)		Identifies patient restraint location— waist/wrist (page 18)
	Do not step or stand on (page 35)		Identifies patient restraint location— wrist (page 18)

Symbol	Description	Symbol	Description
	Foot extend and retract position indicator		Identifies patient restraint location—ankle (page 18)
	Do not use with Oxygen Tents  Can be green or blue		Identifies patient restraint location—arm up (page 18)
	Ground plug—only use grounded plug outlets		Bed Up and Bed Down warning: watch IV poles and traction equipment when you use bed up or bed down controls (page 118)
	Transport warning (page 116)		Auxiliary outlet warning: must consult accompanying documents
	Auxiliary outlet warning: must consult accompanying documents		Identifies battery installation location
	Electrical shock warning: unplug all power cords before service		Identifies mains fuse
	Turn Assist warning (page 109)		Electrical connection location
	Mattress install sequence		Set Foley Limit warning (page 74)
	Mattress connection		Warning: no equipment storage
	Mattress compatibility identification (page 104)		Patient minimum and maximum weight range (page 1)
	Mattress compatibility identification (page 104)		Medical Bed for Adults



Symbol	Description	Symbol	Description
	Total bed weight including the safe working load is 550 kg (1213 lb); the bed weight excluding the safe working load is 225 kg (562 lb) minimum		Safe Working Load for the bed (this includes the weight of the patient, mattress, and accessories that are on the bed)
	Complies with Singapore radiocommunications requirements		Scale class identifier—identifies the scale as EN 45501 Class III
	Complies with the requirements of Japan Ministry of Internal Affairs and Communication		
	Beds with the NAWI EN 45501 scale CE—shows that the scale meets the requirements of the NAWI directive M—shows that the scale is certified to weigh in the approved bed position ZZ—numeric digits show the year of manufacture 0122—identifies the Certifying Notified Body		
	Without permission granted by the NCC, any company, enterprise, or user is not allowed to change frequency, enhance transmitting power or alter original characteristics as well as performance to an approved low power radio-frequency device. The low power radio-frequency device shall not influence aircraft security or interfere with legal communications; if found, the user shall cease operating immediately until no interference is achieved. The said legal communications means radio communications is operated in compliance with the Telecommunications Management Act. The low power radio-frequency devices must be susceptible with the interference from legal communications or ISM radio wave radiated devices.		
	California Proposition 65 label		
<b>Foot-End SafeView+ Alerts Option</b>			
	Bed Exit Alert—OFF indicator (page 26)		Siderail position indicator (page 26)
	Bed Exit Alert—ON or SILENCE indicator (page 26)		Bed in the lowest position indicator (page 26)
	Heart rate or Respiration rate (HR/RR) Alarm—ON or SILENCE indicator (page 26)		<b>WatchCare</b> Alert—On or SILENCE indicator (page 26)

Symbol	Description	Symbol	Description
<b>Experience Pod (overhead arm) Device Option</b>			
	Steps to remove the overhead arm (page 28)		Transport position of the overhead arm (page 28)
	Steps to remove the P7926A07 overhead arm (page 28)		Watch doors and walls during transport with an overhead arm (page 28)
	Do not allow the patient to use the overhead arm to assist them to get out of bed (page 28)		Overhead arm light location (page 28)
<b>Other</b>			
	WARNING (yellow and black)	<b>IPX4</b>	(Bed and patient pendant only) According to IEC 60529, Rating for protection against fluid ingress and identified as equipment that is protected against spraying and splashing water
	CAUTION (white and black)		Type B applied part according to IEC 60601-1
	ATTENTION: Consult accompanying documents		MEDICAL—GENERAL MEDICAL EQUIPMENT AS TO ELECTRICAL SHOCK, FIRE AND MECHANICAL HAZARDS ONLY IN ACCORDANCE WITH AAMI ES60601-1, IEC 60601-1, IEC 60601-2-52, CAN/CSA C22.2 NO 60601-1 AND IEC 60601-2-49
	Manufacturer		Conforms to the European Medical Device Directive 93/42/EEC

Symbol	Description	Symbol	Description
	Manufacture date		Must consult accompanying documents
	Power Transport Pod (page 119)		Complies with Australian radiocommunications requirements
	Medical Device		Do not throw away—indicates the need to recycle the item in accordance with local regulations.

## ALARM, ALERTS, AND INFORMATION INDICATORS

The Information Indicators provide the caregiver with audible indicators and visual indicators.

For detailed information about the Bed Exit Alert and <30° Head Angle Limit, see “Bed Exit Alert System” on page 49 and “Head Angle <30° Limit” on page 47.

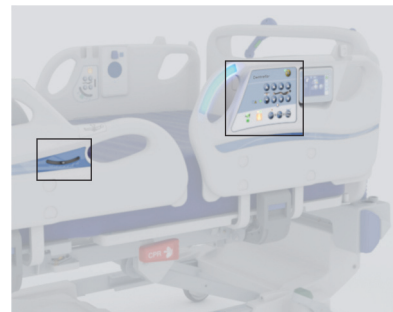

### NOTE:

There must be either AC or battery power to the bed for the indicators to operate.

### LOW PRIORITY ALARM

If the HR and RR Monitoring System option is active, a two-tone alarm will sound every 3 seconds to indicate that a HR or RR alarm is active. and a priority nurse call is sent to the nurses station (for beds equipped and connected to a Nurse Call System).

### BEEP ALERTS

A single beep will sound when an activity is successful.

A triple beep will sound to indicate that you should look at the touchscreen, attention is needed.

For a critical fault, a triple beep will sound every 10 seconds until the user acknowledges the error on the touchscreen. Follow the on-screen instructions. If the critical fault is not resolved, the triple beep will sound again after an hour. The cycle will continue until the issue is resolved.

A low volume repeating triple beep every 10 seconds will sound to remind you that the **Bed Exit** is silenced and should be resumed before you leave the room.

A quadruple beep (four beeps) will sound to indicate a Bed Exit alert.

A continuous tone will sound to indicate a serious bed malfunction and that immediate attention is needed.

## VERBAL ALERTS

These Verbal Alerts are available on some models:

- "Please don't get up."
- "The Care Team has been called."
- "Brake not set."
- "Function unavailable."
- "Call light not connected."
- "Obstacle detected!"

The Verbal Alerts can be disabled through the touchscreen except for the "Brake Not Set" alert (see "Voice Alerts" on page 71). The "Brake Not Set" verbal alert cannot be disabled.

## BED EXIT INDICATOR

The Bed Exit indicator is a visual indicator on the caregiver control panel that will be green when the Bed Exit feature is on.



## ALERT SILENCE INDICATOR

The Bed Exit Alert Silence indicator is a visual indicator on the caregiver control panel. When the Alert Silence indicator is on, the bed stops monitoring patient movement temporarily (30 seconds default).



### NOTE:

This will only silence Bed Exit Alerts.

## BRAKE NOT SET ALERT

The Brake Not Set alert is a visual and audible alert. When the bed is plugged into AC power, and you release the brake, the alert indicator on the caregiver control panel will come on, an audible alert will sound, and a message will show on the touchscreen. To turn the alert off, either unplug the bed (for transport) or set the brakes. The indicator will stay lit when the bed is unplugged, and the brake is not set.



## SERVICE REQUIRED INDICATOR

The Service Required indicator shows and flashes on the touchscreen when the bed detects a malfunction. Contact your facility-authorized maintenance persons or local Hill-Rom representative for assistance.



## BED IN LOWEST POSITION INDICATOR

The Bed in Lowest Position indicator comes on when the bed is in the lowest position.



## BATTERY CHARGING INDICATORS AND BATTERY BACKUP

### Bed Frame Battery Backup

The bed has an automatic battery backup feature. When AC power is not being supplied to the bed and there is sufficient battery power, the battery permits the bed articulation functions to be engaged from any of the caregiver bed position controls except the Lockout control. The battery also powers the nurse call function if the communication cable is plugged into a Nurse Call System.

While on battery power, the bed will operate as follows:

- All caregiver bed articulation controls will operate.
- The Bed Exit and Scale functions will **not** operate.
- If Bed Exit is on, it will turn off when the bed is powered by battery backup. When AC power is restored to the bed, Bed Exit will resume in the Bed Exit mode that it was previously set to.
- The **Centrella** max mattress will stay inflated, but it will not adjust pressures or operate turn assist or max inflate.
- The **Centrella** pro+ mattress **Microclimate Management (MCM)** function will not operate.



Touchscreen while on battery backup

To **activate** the battery when the bed is unplugged from AC power, press and hold any articulation control until the articulation starts. There will be a delay of 1-2 seconds before the articulation control activates the battery.

#### NOTE:

The battery does **not** support these: Patient controls, Auxiliary Outlet, Scale, Bed Exit Alert System, HR and RR monitoring, or the air support system.

The battery stays engaged for 1 minute after the last control is pressed, then goes into a sleep mode.

If the Battery Indicator changes from Charged to Low consistently within four hours of being unplugged from AC power, replace the battery.

If the battery has no charge, it may take up to 24 hours to charge to operational status.

To make sure the battery is always charged, plug the bed into an AC power outlet whenever possible.

There are two bed frame battery charge indicators on this bed:



Caregiver Control Panel—Bed Battery Charge Indicator



Touchscreen—Bed Battery Charge Level Indicator

#### Caregiver Control Panel—Bed Frame Battery Charge Indicator

The battery backup indicator on the caregiver control panel shows the battery status:

- **On** = The battery is charging.

- **Flashing** = The bed is powered by battery backup, or the battery needs to be charged. A triple beep sounds every two minutes when the battery reaches a low condition, and the bed is unplugged.
- **Off** = The battery is not engaged, or the battery charge is critically low and cannot operate the motors.

### Touchscreen Bed Frame Battery Charge Level Indicator

The battery charge status shows at the top of the touchscreen. The screen will dim 10 seconds after the last control is pressed, then will go to sleep after 30 seconds. The screen will come on when AC power is restored to the bed.



**Low**—the Low indicator (one yellow bar) flashes when the battery charge is low. A triple beep sounds every two minutes when the battery reaches a low condition, and the bed is unplugged.

### Powered Transport Battery Charge Indicator



#### CAUTION:

**Caution**—For transport, a fully-charged battery is preferred. If the battery charge is low, before you unplug the bed, put the bed in the transport position before any transport. Connect the bed to AC power as soon as possible.

Beds equipped with powered transport have a Transport Pod on the right-side push handle, at the head end of the bed.

The battery charge indicator on the Transport Pod shows the status of the battery:

- **On** = The battery is charged.
- **Flashing** = The battery is low.
- **Sequenced Flashing** = The battery is charging while the bed is plugged in.
- **Off** = The battery is too low to operate the powered drive system.

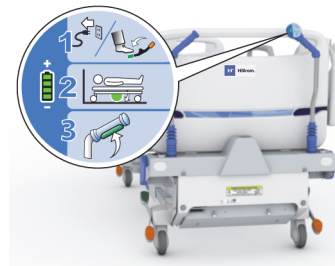

For transport instructions, see "Use the Powered Transport System" on page 119.

## BED FRAME FEATURES

### CPR CONTROL

A red CPR release handle is on both sides of the upper frame in between the head and intermediate siderails.



### Use the CPR Control

1. **Pull and hold** the **red** CPR handle until these occur:
  - The head, knee, and foot sections are flat.
  - The bed levels from a Trendelenburg or Reverse Trendelenburg position.



#### NOTES:

- If you release the handle during its operation, the head section will stop lowering.
  - If the bed has a **Centrella** max mattress—
    - The bladders will go into Max Inflate to support a CPR board.
    - An alert will sound shortly before 60 minutes of being in CPR to alert the caregiver that the mattress will transition to Normal mode or allow you to reset the timer.
    - A countdown timer will show on the touchscreen.
  - The mattress **will not** go into Max Inflate if the bed is being powered by the battery backup.
2. Release the handle.
  3. Put a CPR board under the patient.

#### NOTE:

The headboard, patient helper, and/or overhead arm can be removed for patient access for patient intubation or to insert a central line.

Activation of the CPR mode affects these unit alerts and functions:

- If the Bed Exit Alert and/or <math><30^\circ</math> Head Angle Limit are armed prior to the CPR transition, they will be canceled.
- Controls that were locked out will be unlocked.

## PATIENT RESTRAINTS AND DRAINAGE BAG HOLDERS

### Patient Restraints



#### WARNING:

To help prevent injury and/or equipment damage, obey these **warnings**:

- **Warning**—Restraints must be attached to the articulating section of the bed at the correct attachment points.
- **Warning**—Do not use the Turn Assist feature while a patient is restrained.

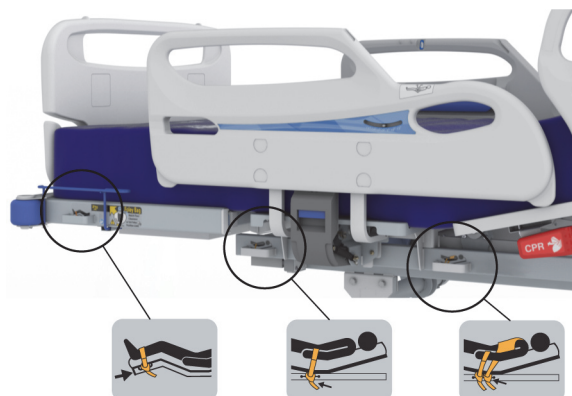

There are three patient restraints per side of the bed. The bed facilitates the use of ankle, waist/wrist, and chest restraints.

As an option, the bed can be equipped with a patient restraint on each side at the head end.

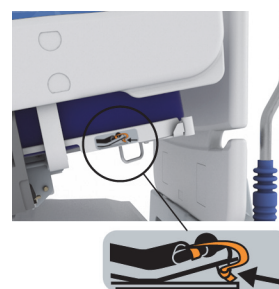

Hill-Rom makes no recommendation in regard to the use of physical restraints. Users should refer to legal restrictions and facility protocols before physical restraints are used.

### Drainage Bag Holders



#### CAUTION:

To help prevent equipment damage, obey these **cautions**:

- **Caution**—Use **caution** when you raise or lower a siderail when a drainage device is present.
- **Caution**—Do not hang drainage bags on the siderails during transport.
- **Caution**—Use **caution** when you put the drainage bag tubing in position. Keep it away from moving parts.
- **Caution**—When you use the Chair control, lower the bed, or use the Reverse Trendelenburg control, make sure that the drainage bags do not touch the floor. Remove them if necessary. Follow facility protocol if the drainage bags touch the floor.

The bed is equipped with a drainage bag holder on each side of the bed at the foot end. The holders will accommodate a variety of drainage devices. Follow your facility protocol for placement of drainage devices.

Make sure drainage bags are placed so they will not touch the floor during bed articulations, see "Foley Position Limit" on page 74.

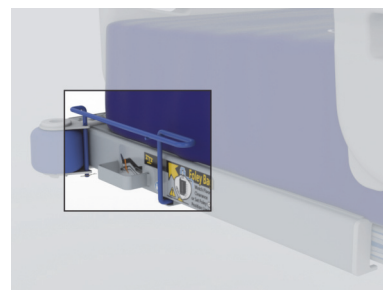



**NOTE:**

The scale reading will be affected by the weight of the drainage bags on the bed. To not include the drainage bags in the weight, empty or lift the drainage bags off of the holders.

**POWER CORD**

The bed may have two power cords:

- The **gray** power cord at the head end of the bed supplies power to the bed and charges the batteries for the bed frame battery backup and the **IntelliDrive** Transport System.
- The **white** power cord at the head end of the bed supplies power to the optional auxiliary outlet.

**NOTE:**

The gray power cord should be plugged into AC power whenever possible to keep the batteries charged.

**CORD HOLDERS**

Cords can be hung in the openings on the sides of the head- and footboards. Wrap the cords around the openings so that they do not touch the floor.

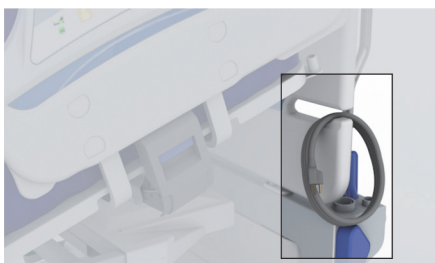
**NOTE:**

Remove the cords from the head- or footboard before you remove the board.

**BRAKE AND STEER CONTROLS****WARNING:**

To help prevent injury and/or equipment damage, obey these **warnings**:

- **Warning**—Unless you are to transport a patient, always set the brakes when the unit is occupied. Make sure the brakes are set before any patient transfer on to or off the bed. Failure to do so may cause injury or equipment damage.
- **Warning**—Make sure your feet are not under the pedals during brake and steer operation.

The brake and steer controls include brake pedals above the foot-end casters and brake and steer pedals above the head-end casters. There are three positions:

- **Brake**—to prevent the unit from moving, step down on the **orange** brake pedal until it is in the full downward position.
- **Steer**—to move the unit in a straight line and guide it through hallways, step down on the **green** steer pedal until it is in the full downward position.
- **Neutral**—to move the unit in any direction, move the pedal to the **level** position. The neutral position helps with sideway movements in a room or a small, enclosed area, or to align the unit with another surface.

**To Activate**

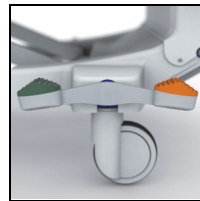
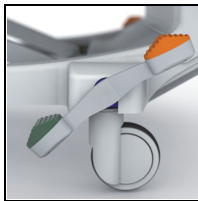
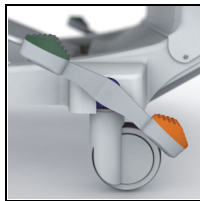

Head-End Control

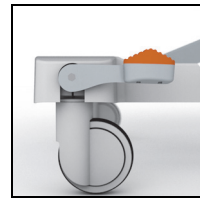
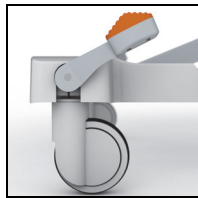
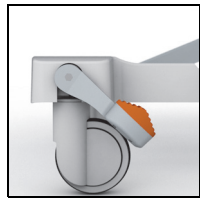

Foot-End Control

**Brake (orange pedal)**

Step down on the orange brake pedal until it stops.

**Steer (green pedal)**

Step down on the green steer pedal until it stops.

**Neutral**

Move the brake or steer pedal to the level position.

There are three steer systems available on the bed: Corner Steer, 5th Wheel, and **IntelliDrive** Transport System.

- **Corner Steer:** The foot-end casters lock in-line ready for system movements.

**NOTE:**

Make sure the foot-end casters are in a trailing position before the bed is put in steer. Failure to do so could result in erratic movement of the bed.

- **5th Wheel:** When the brake and steer pedal is placed in steer, the front casters do not lock into steer mode. All four casters on the bed are put into the neutral position. This allows the bed to pivot on the 5th wheel for tighter turns and easier steer.
- **IntelliDrive Transport System:** The steer mechanism operates as above in 5th wheel only with a power drive wheel.

When the unit is connected to AC power, and you release the brake, these will occur to let you know that the brake is not set:

- The Brake Not Set alert will sound.
- The alert indicator on the caregiver control panel will show.
- A message will show on the touchscreen.
- Beds equipped with Voice Alerts will alert "Brake not set."

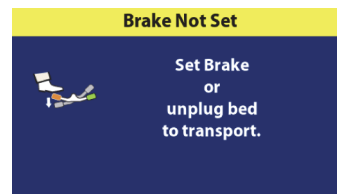

To address the alert, either unplug the unit (for transport) or set the brake.

## HEADBOARD

The headboard attaches to the head end of the frame.

The headboard can be removed for increased access to the patient's head.

A caregiver can quickly remove or attach the headboard in a single step without the use of tools.

### To Remove

1. Remove any cords from the headboard.
2. Lift the headboard straight up.

### To Install

Align the headboard pins with the sockets in the frame, and then lower the headboard into the sockets. Push the headboard down until the bottom rests on the frame.



## FOOTBOARD



### WARNING:

**Warning**—When the footboard is removed from the bed, do not lay the footboard flat on the floor. Store the footboard in a position or location so that it does not come in contact with biohazards or cause a tripping hazard. Failure to do so may cause injury or equipment damage.



### CAUTION:

**Caution**—Do not exceed the 55 lb (25 kg) load capacity (safe working load) of the footboard. To do so could cause equipment damage.

The footboard attaches to the articulating foot section, and it remains perpendicular to the surface of the foot section at all times.

A caregiver can quickly remove or attach the footboard in a single step without the use of tools.

### To Remove

1. Remove any cords from the footboard.
2. Lift the footboard straight up.

### To Install

Align the footboard pins with the sockets in the frame and then lower the footboard into the sockets. Push the footboard down until the bottom rests on the frame.



## EQUIPMENT SOCKETS

There are four equipment sockets for the attachment of accessories. They are at each corner of the bed.

The equipment sockets can be used to mount IV poles and oxygen tank holders.

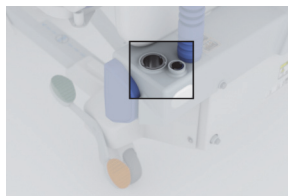

### NOTES:

- Any equipment in the foot-end equipment sockets will be included in the scale reading.
- Remove any equipment that was not included during the bed zero process.



## WALLGUARD BUMPER SYSTEM

The **WallGuard** Bumper System protects the perimeter of the bed when it is being moved or transported.

Roller bumpers at the foot end of the bed protect the walls and doorways when you transport the bed.

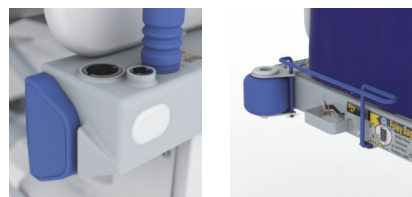

## HIP POSITION LOCATOR

The hip position label on the intermediate siderails identifies the correct position of the patient's hip while on the bed.

The correct placement of the patient helps to minimize patient migration to the foot end of the bed when you raise the head section.

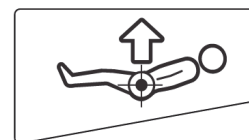

## LINE-OF-SITE ANGLE INDICATORS

- Beds equipped with a **mechanical head angle** indicator, on the outside of the right head siderail, mechanically show the approximate angle of the head section from 0° to 85° with respect to the floor.

The degree where the indicator ball rests is the approximate angle.

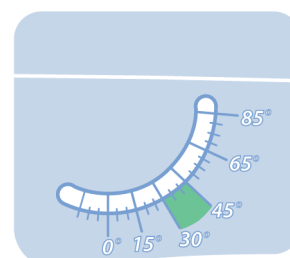

- The **digital head angle** display on the touchscreen gives a more accurate degree of head elevation.



- The **Line-of-Site Trendelenburg/Reverse Trendelenburg Angle** indicators on the intermediate siderails give an estimated degree of the bed's angle.

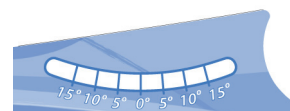

## HEAD AND INTERMEDIATE SIDERAILS

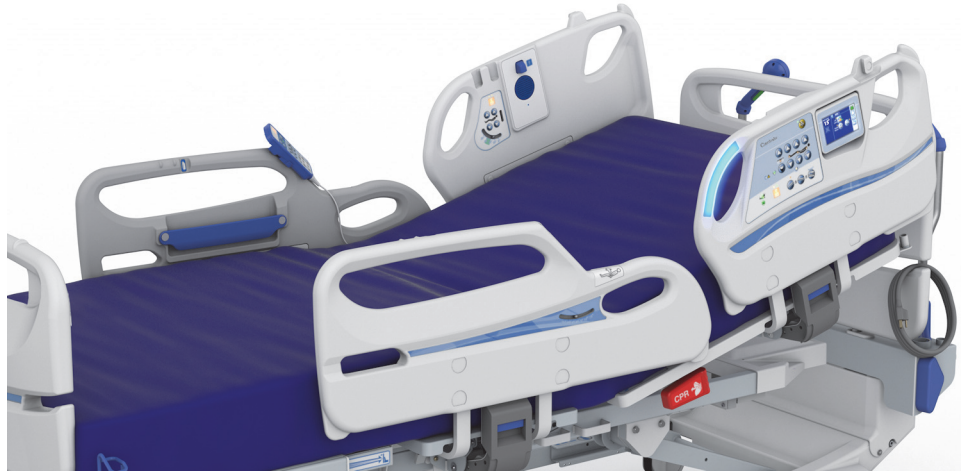

### WARNING:

To help prevent serious injury and/or death, obey these **warnings**:

- **Warning**—Evaluate patients for entrapment and fall risk according to facility protocol and monitor patients appropriately.
- **Warning**—Make sure that all siderails are fully latched when in the raised position.
- **Warning**—Stay clear of pinch points and moving parts during siderail operation.

### NOTES:

- Siderails are intended to be a reminder to the patient of the bed's edges, not a patient-restraining device. When appropriate, Hill-Rom recommends that medical persons determine the correct methods necessary to make sure a patient stays safely in bed.
- Siderails in the raised position are intended to make the patient aware of the proximity of the edge of the mattress and to assist in patient entry and exit.



### CAUTION:

**Caution**—Before you raise or lower a siderail, make sure that the area around the siderail is free of objects and devices. Failure to do so could cause equipment damage.

### To Lower a Siderail



### WARNING:

**Warning**—When the bed is in its lowest position, make sure that your feet are out from under the siderail before you lower the siderail. Otherwise, injury could occur.

Lift up on the recessed blue release handle that is on the lower part of the main siderail support. The siderail has a dampening mechanism that slowly lowers the siderail.

Gently leaning into the siderail may make it easier to latch and unlatch in some situations. For example, this may be helpful when siderail pads are installed.



### To Raise a Siderail

1. Pull the siderail up and push it in until it latches into the locked position. You will hear a **click** when the siderail latches into the locked position.
2. After you hear the **click**, gently pull on the siderail to make sure it is latched correctly.



#### CAUTION:

**Caution**—Do not use the siderails to move the bed. Always push or pull from the headboard or footboard. Otherwise, equipment damage could occur.

### IllumiGuide Siderail Handgrip Option

Beds equipped with the **IllumiGuide** handgrip allow the patient to easily find the grip location on the siderail when the patient gets back into bed. The light will stay on for 15 minutes after the patient exits the bed or 2 minutes after they return to the bed. The **IllumiGuide** handgrip also identifies the Bed Exit status. You can turn the light off or on through the Settings menu control on the touchscreen. See “IllumiGuide Siderail Handgrip (blue light only)—ON/OFF” on page 69.



#### Light Status

**Blue**—the Bed Exit Alert is **off**, and the patient has left the bed.

**Flashing Amber**—the Bed Exit Alert is **on** and is alerting.

**Solid Amber**—the active Bed Exit Alert is silenced and is waiting to re-arm.

**Off**—the Bed Exit Alert is off with the patient in bed, or the **IllumiGuide** handgrip option has been turned off.

### Line Manager



#### WARNING:

**Warning**—Make sure that the lines are not pinched or kinked and that there is sufficient slack in the lines for bed articulations and patient movement. Failure to do so could cause injury or equipment damage.

Each head siderail has an integrated Line Manager on the top of the siderail. The Line Manager helps to keep lines (such as IV lines, suction lines, etc.) together and away from the articulating frame.



## USB Charging Port



### WARNING:

To help prevent injury and/or equipment damage obey these **warnings**:

- **Warning**—Never allow excess cable length near the patient’s head or neck. To do so could result in strangulation. Secure any excess cable to the siderail or other suitable object.
- **Warning**—Do not allow the conductive parts of the patient charging cable, to come into contact with other conductive parts, this includes earth ground. Otherwise, an electrical short might occur, risking electric shock to the patient and damage to their portable electronic device.

The USB charging port is on the right-head siderail.

### NOTE:

The USB charging port may not be compatible with all devices.

The USB charging port can be used to charge personal electronic devices (PED) such as cell phones, computer tablets, portable media players, and pocket computers. The port is not designed for devices that require less than 170 mA of power such as USB reading lights but supports up to 2.4 A of current. If the device does not charge, make sure the setting for the charging port is **On**.

To turn on or off the USB charging port, see “USB Charging Port—On/Off” on page 70.



## Urinal Holder

Each intermediate siderail has an integrated Urinal Holder on the top of the siderail.

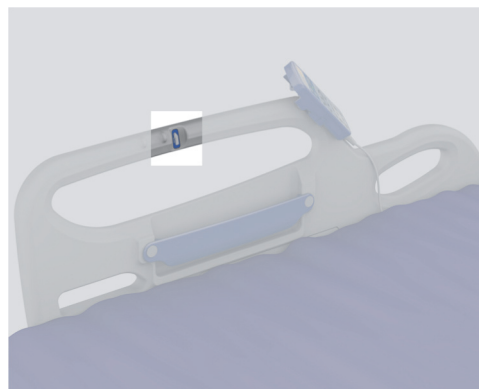

## Patient Storage

Patient storage is provided on both intermediate siderails.

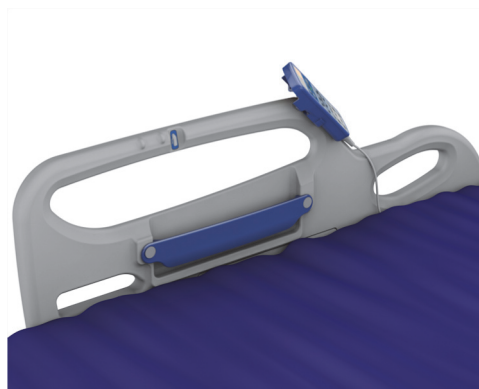

## MOTION ACTIVATED NIGHT LIGHT

The night light is on the base frame, at the foot end. The light is on when the bed is plugged into AC power. The light gets brighter when the patient moves to the edge of the bed or gets out of the bed.



## SAFEVIEW+ ALERTS OPTION

Beds equipped with **SafeView+** Alerts indicators show the bed status at the foot end of the bed for these alerts: fewer siderails up than the set protocol, Bed Exit Alert, Bed in Lowest position, and HR and RR Alert. With the exception of the HR and RR Alarm, the **SafeView+** Alerts indicators project on to the floor to provide an additional visual status of these bed conditions.

The projections may be turned on or off through the Settings menu control on the touchscreen. See “SafeView+ Alerts Floor Projections Option—ON/OFF” on page 68.



### NOTE:

New Patient Zero will reset the **SafeView+** Alerts option to the facility's default settings.

## SafeView+ Alerts Indicators Status

### Siderail Protocol Status—On

A **green** siderail indicator shows when the minimum number of siderails are up as set in the siderail protocol. The indicator will **flash amber** if fewer siderails are up than the set siderail protocol.



### NOTES:

- If more siderails are up than the set siderail protocol, a green siderail indicator will still show.
- The siderail protocol can be changed for special patient needs through the **Settings** menu control on the touchscreen. See “Siderail Protocol” on page 70.



**Bed Exit Alert Status—On**

A **green** Bed Exit Alert indicator shows when a patient is in bed and the Bed Exit Alert is armed. The indicator will **flash amber** when a Bed Exit Alert occurs.

The Bed Exit Alert will show **solid amber** when the Bed Exit Alert is silenced.



**Bed Exit Alert Status—Off**

A **blue** crossed out Bed Exit Alert indicator shows when the Bed Exit Alert is off.



**Bed in Lowest Position Status—On**

A **green** Bed in Lowest Position indicator shows when the bed is in the lowest bed position. The indicator will **flash amber** when the bed is not in the lowest bed position.

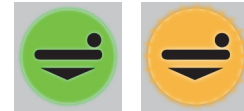

**HR and RR Monitoring Status—On**

A **green** HR/RR indicator shows when the HR and RR monitoring is **On**, a patient is in the bed, and the HR/RR measurements are within the HR/RR thresholds.

The indicator will **flash amber** when an HR/RR measurement is outside the set thresholds. If the indicator is **white**, the HR and RR monitoring is **On**, but either the patient is not in the bed, or the system could not detect the patient’s HR or RR.



The HR/RR Alarm will show **solid amber** when the HR/RR Alarm is silenced.

**WatchCare Alert Status**

**Green light**—shows when the **WatchCare** Incontinence Management System is On, and a smart pad is present and is being monitored.



**Flashing amber light**—shows when an incontinence event occurs.



**No light**—the system is not active. Make sure it is plugged into AC power.



**Solid white**—the system is on, but the reader does not detect any smart pads on the bed.

Refer to the *WatchCare Incontinence Management System Instructions for Use and Service Manual* (196414) for more information about the **WatchCare** Incontinence Management System.

**NOTES:**

- If one of the **SafeView+** Alerts projectors is **on** when it should be **off**, contact your authorized maintenance persons.
- If the **SafeView+** Alerts projectors are **on** when there is no weight on the bed, zero the scale.

### Experience Pod Device (Overhead Arm) (P7926A AND P7926A07) OPTION

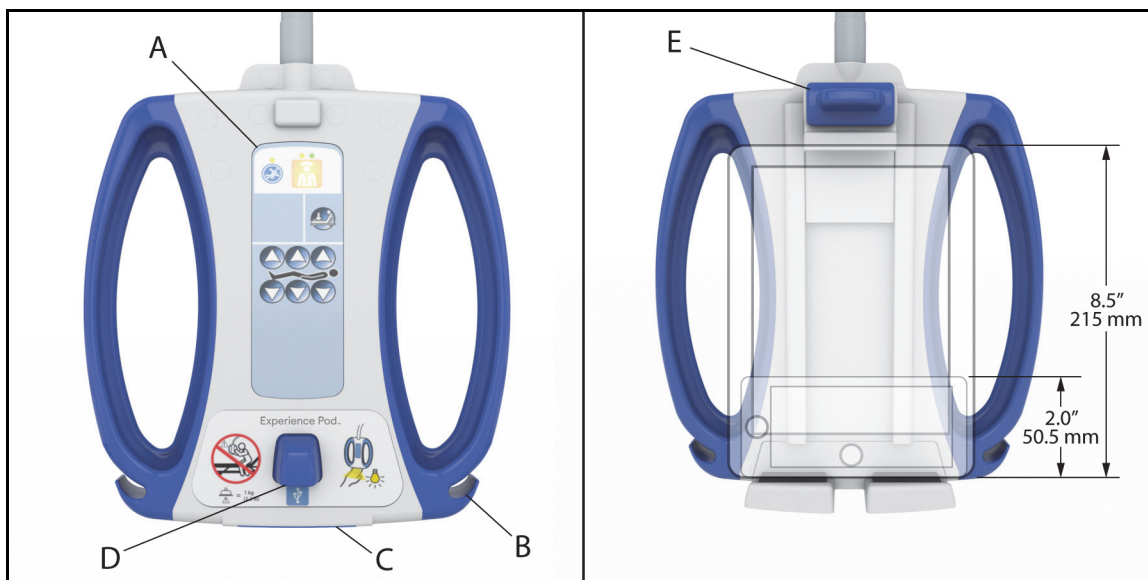

Item	Description	Item	Description
A	Patient controls (optional)	D	USB charging port
B	PED cord storage	E	PED holder
C	Reading light (optional)		



**WARNING:**

To help prevent injury and/or equipment damage, obey these **warnings**:

- **Warning**—Do not exceed the 1 kg (2.2 lb) load capacity of the Overhead Arm.
- **Warning**—Do not remove or install the Overhead Arm assembly while it is in a position over a patient.
- **Warning**—Stay clear of pinch points and moving parts when putting the Overhead Arm in the transport position.
- **Warning**—Put the Overhead Arm in the transport position prior to transport (see Step 3 on page 30).
- **Warning**—Instruct patients to never use the Overhead Arm to assist them when they get in or out or reposition themselves in the bed.
- **Warning**—When the Overhead Arm is installed and you adjust the bed and/or head section height, be careful that the arm does not contact the patient.

With the **Experience Pod** Device, you can—

- Articulate the bed (optional)
- Send a Nurse Call if the bed is connected to a Nurse Call System (optional)
- Charge a PED
- Put your PED in the PED holder (see above for the PED dimensions supported)
- Store the PED charging cord
- Turn on/off the reading light (optional)
- Adjust the **Experience Pod** Device for optimal use



**NOTE:**

The USB port is not designed for devices that require less than 170 mA of power, such as USB reading lights but supports up to 2.4 A of current.

**To Install**

1. Make sure the bed’s brake is set, and a patient is not in the bed.
2. Lower the bed to its lowest position.

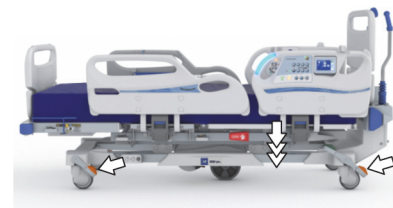

3. Install the **Experience Pod** Device into the accessory socket at the head end of the bed. Make sure the arm assembly is fully inserted into the socket.



**WARNING:**

**Warning**—Make sure that the arm is correctly attached in step 4. Otherwise, it may fall. Injury or equipment damage could occur.

4. Rotate the base tube until the plunger locks into the accessory socket. You will hear a **click** when the plunger locks into position. The blue strain relief faces away from the headboard.

**Or**



For the P7926A07, from underneath the bed frame, insert the pin into the slot in the base tube. Install the retaining ring on to the pin to lock the base tube in position.

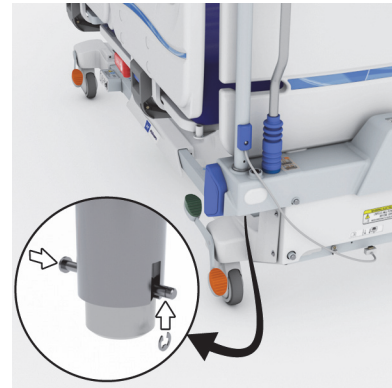

5. Connect the **Experience Pod** Device communication cable to the bed.



### To Remove

1. Make sure the bed's brake is set, and a patient is not in the bed.
2. Lower the bed to its lowest position.

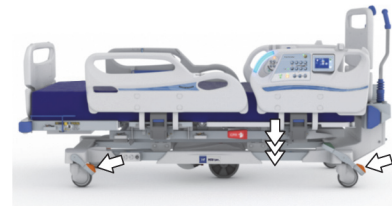

3. Put the **Experience Pod** Device in the transport position as shown.



4. Disconnect the communication cable from the bed.



5. Pull straight up on the **Experience Pod** Device to remove it from the accessory socket.

**Or**



For the P7926A07, from underneath the bed frame, remove the retaining ring and pin from the base tube. Pull straight up on the **Experience Pod** Device to remove it from the accessory socket.

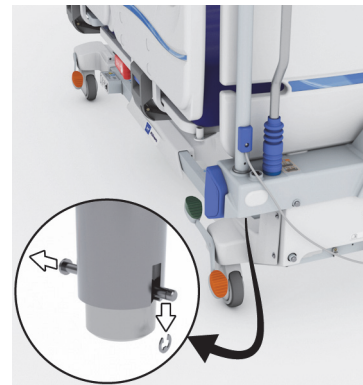

6. To store the **Experience Pod** Device, turn the device over and safely stand it up against a wall or put the device in a storage location.



## AUXILIARY OUTLET OPTION



### WARNING:

To help prevent injury and/or equipment damage, obey these **warnings**:

- **Warning**—Do not use the auxiliary outlet for life support equipment. There is no battery backup. Plug life support equipment directly into facility power supply.
- **Warning**—Do not use oxygen enriched sources near the auxiliary outlet.
- **Warning**—Do not plug the auxiliary and power cord into the same wall outlet. Plug the power cords into different outlets on separate circuits. Failure to do so can cause equipment damage or tripping of facility power breakers.
- **Warning**—Before you move the bed, make sure both power cords are unplugged and stored correctly.



### CAUTION:

**Caution**—Failure to store the auxiliary outlet power cord when not in use could cause damage from bed articulation.

The auxiliary outlet option is a convenient source of AC power for accessory devices. **The auxiliary outlet is not intended for life support equipment.** The outlet is on the left side of the base frame.

The outlet provides up to 10 A of AC current (120 V AC beds). Beds that have this option are equipped with two power cords, one for the auxiliary outlet and one for the bed. The outlet is isolated from the bed's AC power supply.

The outlet power cord is white, and the bed power cord is gray.

---

## POINT-OF-CARE BED CONTROLS



### WARNING:

To help prevent injury and/or equipment damage, obey these **warnings**:

- **Warning**—Mechanical parts under the bed pose a risk of serious injury. Exercise control over visitors, especially children, to keep people out from under the bed and prevent unauthorized access to the bed articulation controls.
- **Warning**—Before you press a bed articulation control, make sure that objects and devices are away from the bed's articulating sections.
- **Warning**—Make sure to always lock out the articulation controls during traction.
- **Warning**—Monitor lines closely during articulations. Always use good line management techniques, particularly as the head section rises.

## CAREGIVER BED CONTROLS

This section describes the caregiver bed controls that are on the outside of the head siderails. Not all controls listed are present on all beds.



### WARNING:

To help prevent injury and/or equipment damage, obey these **warnings**:

- **Warning**—Instruct visitors not to operate the caregiver controls or patient injury could occur. They may assist the patient with the patient controls.
- **Warning**—Lockout the bed articulation controls when patients, caregivers, or family members must be kept from inadvertently activating the bed functions.

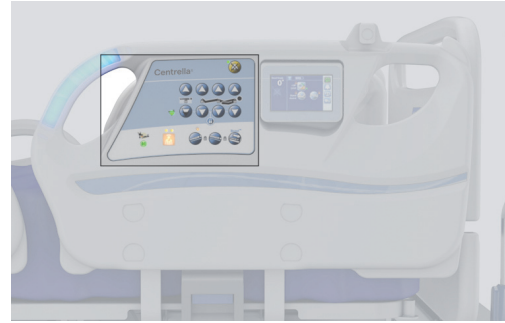

## Bed Exit Alert System

### To Activate the Bed Exit Alert System

The Bed Exit Alert system is activated through the touchscreen, see “Bed Exit Alert System” on page 49.

When a Bed Exit mode is armed, the Bed Exit indicator will be green.



When the system is armed and it detects an alert condition for the Bed Exit mode setting, the following occur even if the patient returns to the bed:

- An audible alert comes on.
- The amber Alert Silence control indicator flashes.
- A priority nurse call is sent to the nurse’s station (for beds equipped and connected to a Nurse Call communication system).

### To Silence the Bed Exit Alert System without Deactivating the System

When a Bed Exit mode is armed, you can silence the alert system. During the Silence Mode, the system stops monitoring the patient movement; therefore, **the system will not notify the care team or cause an alert**. While the system is in the Silence Mode, you can change the position of the patient or assist the patient out of the bed. You can silence the alert before it sounds (preemptively) or after it sounds.

To silence the alert system before or after it sounds—press the Alert Silence control until its indicator is on solid.



### NOTE:

The Bed Exit Alert system will try to re-arm after 30 second or when the patient returns to the bed. To increase the alert silence time to 1 or 5 minutes, see “To Silence a Bed Exit Alert” on page 51.

## Lockout

The Lockout control disables the bed’s articulating function (for both the patient and caregiver).

If you press the Lockout control and do not press an Up or Down control within a few seconds, or if you do not complete the lockout procedure correctly, the bed will sound a triple beep and a message on the touchscreen will provide instructions on how to complete the task.



### NOTES:

- When CPR is activated, any controls that are locked out will become unlocked.
- Follow your facility’s protocols for lockouts to reduce the likelihood of unauthorized use of the bed controls.
- If you attempt to use a locked-out control, a triple beep will sound, a message will show on the touchscreen, and a voice alert (if equipped) will say “This bed function is unavailable” to notify you to check the lockouts.
- Some locked out frame articulations may cause other functions to be locked. See the table below.

Locking Out:	Automatically Locks Out these functions:						
	Boost	Trendelenburg	Reverse Trendelenburg	Bed Flat and level	Chair	<30° Limit	Stand Assist
Head Up/Down	X			X	X	X	X
Knee Up/Down	X			X	X		X
Foot Up/Down	X			X	X		
Bed Up/Down	X	X	X	X			X
Foot Longer/Shorter Extend/Retract							

**To Lock**—press and hold the **Lockout** control, then press the **Up** or **Down** control of the bed function or the **Foot Longer/Shorter** control on the touchscreen. Both patient and caregiver controls are locked out. A single beep sounds and the applicable indicator light comes on to let you know that the function is locked out.

**To Unlock**—press and hold the **Lockout** control, then press the **Up** or **Down** control of the bed function or the **Foot Longer/Shorter** control on the touchscreen. Both patient and caregiver controls are unlocked. A single beep sounds and the applicable indicator light turns off to let you know that the function is no longer locked out.

### NOTE:

If you attempt to use a locked-out control, a triple beep will sound, a message will show on the touchscreen, and a voice alert (if equipped) will say “This bed function is unavailable.” to notify you to check the lockouts.



## Bed Up/Down



### WARNING:

To help prevent injury and/or equipment damage, obey these **warnings**:

- **Warning**—IV poles do not travel with the height of the bed adjustments. Correct the height of the IV pole after any bed adjustments.
- **Warning**—It is recommended that the bed be in the low position when the patient is unattended. This may reduce the severity of any resultant injuries from patient falls.
- **Warning**—When the bed is in its lowest position, make sure that your feet are out from under the siderail before you lower the siderail. Otherwise, injury could occur.

**To raise**—press and hold the **Bed Up** control until the bed is at the desired height.

**To lower**—press and hold the **Bed Down** control until the bed is at the desired height. The bed will slow down as it gets close to the lowest bed position to allow time to move any items that may be between the siderail and the floor.



### NOTES:

- When the bed reaches its lowest position, you will hear a single beep and the Bed in Lowest Position indicator will be green.
- The Bed up/down and head up/down controls can be used at the same time.



## Obstacle Detect System

Beds equipped with the **Obstacle Detect** System sense objects that are between the upper frame and the base frame. The system sensors run along the right and left open sides of the base frame.

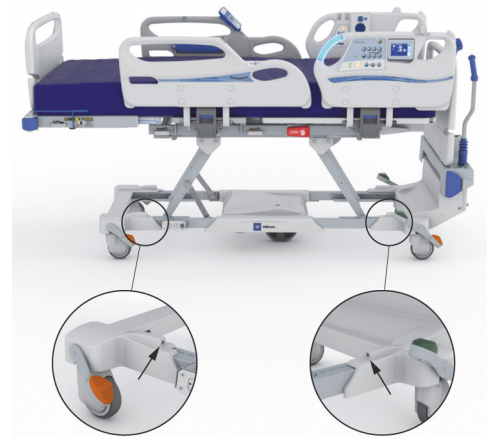

If the system senses an object while the bed is lowering, these will occur to let you know that an object is detected:

- The bed will stop lowering.
- A triple beep will sound.
- A pop-up screen will show on the GCI.
- If equipped, a verbal alert “Obstacle is detected on the left (or right)” will sound.

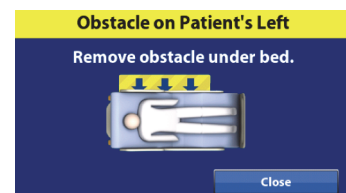

## Head Up/Down



### WARNING:

**Warning**—For patient and equipment safety, make sure to monitor the patient and all patient interface lines during articulation. Failure to do so could cause injury or equipment damage.

The caregiver can adjust the head section to specific angles. The maximum travel for the head section is 65°.

**To raise**—press and hold the **Head Up** control until the head section is at the desired position.

**To lower**—press and hold the **Head Down** control until the head section is at the desired position.

### NOTE:

The **Auto Contour** feature is not active when you use the caregiver controls; it is **only** active when you use the patient controls. See “Patient Controls” on page 38.



## Knee Up/Down

The caregiver can raise or lower the knee section. The knee section has a maximum travel of 30°.

**To raise**—press and hold the **Knee Up** control until the knee section is at the desired position.

**To lower**—press and hold the **Knee Down** control until the knee section is at the desired position.

### NOTE:

To put the bed in an auto contour position, press the Head Up and Knee Up controls at the same time.

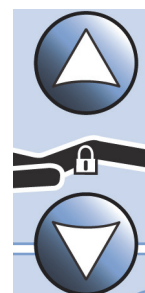

## Foot Up/Down



### CAUTION:

**Caution**—Make sure the drainage bags will not touch the floor. Remove them if necessary. Follow facility protocol if the drainage bags touch the floor.

### NOTE:

The Foley Position Limit can restrict how much the foot section can lower to reduce the likelihood of a drainage bag touching the floor, see “Foley Position Limit” on page 74.

The caregiver can raise or lower the feet and lower extremities.

**To raise**—press and hold the **Foot Up** control to raise the foot section to the desired position. The knees will first raise, then the feet/lower extremities will elevate so the foot end of the bed is parallel to the floor.

**To lower**—for a chair-like position, press and hold the **Knee Up** control until you hear a single beep. Then press and hold the **Foot Down** control to lower the foot section to the desired position.

**To level**—to level the bed from the raised or lower position, press and hold **Knee Down** until the bed stops and you hear a single beep.

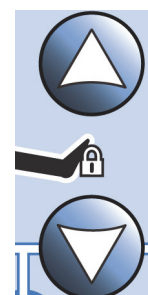

## Trendelenburg and Reverse Trendelenburg



### WARNING:

**Warning**—Make sure the caregiver hands are kept away from the moving parts while operating the bed.

You can use the Trendelenburg and Reverse Trendelenburg controls at any bed height.

**Trendelenburg**—press and hold the **Trendelenburg** control until the foot end of the bed raises relative to the head-end to the desired angle.



Trendelenburg



### CAUTION:

**Caution**—Make sure the drainage bags do not touch the floor. Remove them if necessary. Follow facility protocol if the drainage bags touch the floor.

**Reverse Trendelenburg**—press and hold the **Reverse Trendelenburg** control until the head end of the bed raises relative to the foot end to the desired angle.



Reverse  
Trendelenburg

### NOTES:

- If the Foley Position Limit is set, it will limit the degree of Reverse Trendelenburg.
- If the **Obstacle Detect** System senses an object or if there is interference, the bed will not go down. See “Obstacle Detect System” on page 35 for more information about the **Obstacle Detect** System.

**To return to the flat position**—press the opposite control, **Trendelenburg** or **Reverse Trendelenburg**, or press the **Bed Flat and Level** control on the touchscreen until the bed is at the desired position.

## Boost Position System

The **Boost** Position System’s one-button control levels the legs and head and puts the bed into Trendelenburg. This is helpful when you need to reposition the patient toward the head end of the bed.

The **Boost** Position System will not operate if any bed functions are locked out.



### WARNING:

**Warning**—Monitor lines closely during articulations. Always use good line management techniques, particularly as the head section rises. Failure to do so could cause patient injury or equipment damage.

### To Activate

1. Press and hold the **Boost** control on the siderail until the bed is in the desired tilt position or you hear a single beep.
  - The head and foot sections will go to the flat position.
  - The bed height may adjust to allow the bed to go into Trendelenburg.



- If desired, you can continue to hold the control to raise the knee section for an increased boost. A single beep will sound when the knee section has stopped.
  - If the bed has an air system, the mattress will go into Max Inflate for 15 minutes.
2. Release the **Boost** control when the desired position is reached.
  3. Move the patient to the head of the bed as necessary.

### To return to the flat position

1. Press and hold the **Flat and level** control until you hear the bed beep, indicating the bed is flat.
2. If the bed has a **Centrella** max mattress, at the touchscreen, go to the Surfaces menu, and then press Normal. Or press any Caregiver control on the caregiver panel.

### NOTE:

We do **not** recommend that you transport the patient when the bed is in the **Boost** Position. See “Transport The Patient” on page 116.

## PATIENT CONTROLS

The patient controls are on the patient side of the head siderails.

The standard patient controls include: Nurse Call, Head Up/Down, and Knee Up/Down.

There are head of bed (HOB) angle indicators that patients can use to help them comply with HOB orders.

### NOTE:

The patient head up/down control includes the **Auto Contour** feature. When the patient raises or lowers the head section, the head and knee sections raise or lower at the same time.

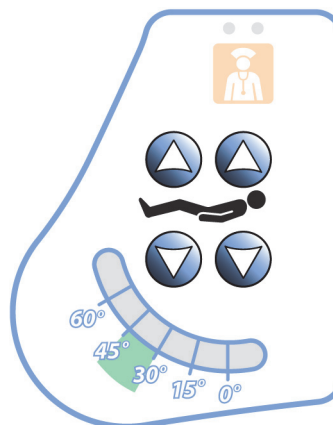

## Nurse Call Control

The patient can use the Nurse Call control to call the nurse when the control is lit.

When a Nurse Call control is activated, a signal is sent to the nurse’s station. Voice communication is provided through a speaker/microphone that is on the inside of both head siderails. See “SideCom Communication System” on page 41.



### To Activate

Press a **Nurse Call** control. These will occur:

- The yellow indicator near the Nurse Call control will come on and a single beep will sound to let you know that the call has been sent. If equipped, a verbal alert “The care team has been called” will sound.
- When the nurse’s station communication line is open, the indicator turns green. The nurse’s station is ready for you to speak.

**NOTES:**

- The Nurse Call controls are always lit, visible, and active if the bed is connected to a compatible Nurse Call System. If the Nurse Call control does not light when connected to the Nurse Call system, contact your authorized maintenance persons.
- The Nurse Call controls cannot be locked out.
- If the Nurse Call control is not visible, there is not a connection to the Nurse Call system, and you cannot send a Nurse Call.
- The **Centrella** bed can communicate these alerts through the standard 37 pin cable:
  - Nurse call
  - Bed exit alert
  - HR/RR alert
- Generic equipment alert (**WatchCare** Incontinence System alerts, if installed. These alerts require a custom Hillrom cable that plugs in to a standard phone jack wall plate.)

**Head Up/Down**

**To raise**—press and hold the **Head Up** control until the bed is at the desired height.

**To lower**—press and hold the **Head Down** control until the bed is at the desired height.

**Knee Up/Down**

**To raise**—press and hold the **Knee Up** control until the bed is at the desired height.

**To lower**—press and hold the **Knee Down** control until the bed is at the desired height.

**Auto Contour Feature**

The **Auto Contour** feature does not activate when either the head section or the knee section is locked out. If only the head section is locked out, you can use the patient controls to adjust the knee section. If only the knee section is locked out, you can use the patient controls to adjust the head section.

**PATIENT PENDANT (HANDHELD REMOTE)**

These controls **may or may not** be on your configuration of the patient pendant depending on the model of the patient pendant you have.

**WARNING:**

**Warning**—Instruct the patient to store the patient pendant in a patient pendant holder when not in use; otherwise, patient injury could occur.

These controls are on every model of the remote control and do not require the bed to be connected to the **SideCom** Communication System:

- Head Up/Down
- Knee Up/Down
- Foot Up/Down
- Stand Assist



**Stay in Bed Indicator**—this is on every model of the remote control. The indicator is on when the Bed Exit is armed.



**Soft (-) and Firm (+) controls**—these controls are only available when the bed has a **Centrella** max mattress (see “Patient Comfort” on page 107). Continuously press and release the Soft (-) or Firm (+) control until you reach the desired comfort level. As you press the control, an indicator turns on to show the firmness level.



The optional controls below require the bed to be connected to a **SideCom** Communication System (see “SideCom Communication System” on page 41).

- **Nurse Call**—sends a Nurse Call to the nurses’ station (see “Nurse Call Control” on page 41).
- **Room Light**—turns the room light off and on.
- **Reading Light**—turns the reading light off and on.
- **Television Control**—turns the television on and off. The volume and channel are controlled by the Volume and Channel controls.
- **Volume Control**—adjusts the volume of the television or radio in the room.
- **Channel Control**—changes channels on the television or stations on the radio in the room.



- **Closed Captioning**—turns the captioning option of the television on and off (if the television is closed captioning capable).
- **Mute**—turns the sound on and off.



### To Store the Patient Pendant (Handheld Remote) on to the Siderail

Align the patient pendant above the pendant holder and slide the remote control on to the holder.

### To Remove the Patient Pendant (Handheld Remote) from the Siderail

Pull out or slide the pendant off the holder.



Patient Pendant Holder Locations

## SIDECOM COMMUNICATION SYSTEM

The **SideCom** Communication System provides a control for Nurse Call and other entertainment features.

The **SideCom** Communication System connector is at the head end of the bed below the headboard.



### NURSE CALL CONTROL

There is a Nurse Call control on the caregiver control panel, the patient controls, and the patient pendant (if installed).

When a Nurse Call control is activated, a signal is sent to the nurse's station. Voice communication is provided through a speaker/microphone that is on the inside of both head siderails.



### To Activate

Press a **Nurse Call** control. These will occur:

- The yellow indicator near the Nurse Call control will come on and a single beep will sound to let you know that the call has been sent. If equipped, a verbal alert "The care team has been called" will sound.
- When the nurses station communication line is open, the indicator turns green. The nurses station is ready for you to speak.

**NOTES:**

- The Nurse Call controls are always lit, visible, and active if the bed is **connected** to a compatible Nurse Call System. If the Nurse Call button does not light when connected to the Nurse Call system, contact your authorized maintenance persons. See “SideCom Communication System” on page 41
- The Nurse Call controls cannot be locked out.
- If the Nurse Call control is not visible, there is not a connection to the Nurse Call system, and you cannot place a Nurse Call.

**WIRELESS CONNECTIVITY OPTION**



**WARNING:**

**Warning**—The wireless module **does not** communicate nurse call information. The bed’s **SideCom** Communication System cable must be connected to the facility network for remote nurse call communications.

The Wireless Connectivity module is **not** intended as a replacement for your wired Nurse Call connection.

The Wireless Connectivity module permits bed and mattress data to be sent to a hospital’s information system without a communication cable; the module **does not** communicate nurse call information. The module has a Location feature that identifies the location of the bed when it is in a facility that has a real-time location system (RTLS) installed. The data is sent through Hill-Rom’s middleware solution, **Voalte SmartSync** System, to the hospital’s information system. (For electrical specifications, see “Wireless System Characteristics” on page 148.)

The module operates only when the bed is connected to AC power; it does **not** operate on battery power.

**Wireless and Bed Location Indicators on the Touchscreen**

When you plug the bed into AC power, the color of the Wireless Status and Bed Location indicators on the touchscreen will identify the wireless connectivity status:

Wireless Status

- **No indicator**—the wireless module is not operating correctly, or it is not receiving power.
- **White outline**—the wireless module is operating correctly, but it is not connected to the wireless network, or it has not been configured.





- **Green bars**—the wireless module is operating correctly and is connected the wireless network.



### Bed Location

- **No Location control**—the wireless module is operating correctly, but it has not received a location, or it has not been configured.

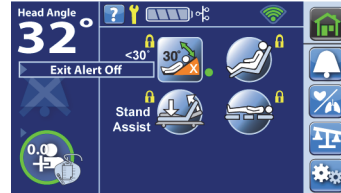

- **Room Number**—the wireless module is operating correctly, it has received a location, and the Location control is pressed.

**NOTE:**

The Location control will not show if there is no wireless connection, or it has not received a location.

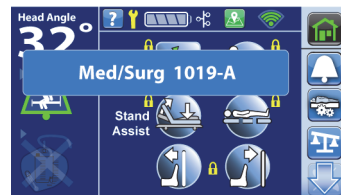

### Asset Tag



**CAUTION:**

To help prevent equipment damage, obey these **cautions**:

- **Caution**—The Wireless Connectivity feature is configured for the Hill-Rom approved Location Asset tag. The location feature may not operate correctly if you use a different asset tag. Contact your local Hill-Rom representative for more information.
- **Caution**—Do not have other wireless devices with 8" (20 cm) of the Location Asset Tag. If their locations are too close, the devices may not operate.

If installed, this tag is used along with the Wireless Connectivity option to identify the bed's location (refer to "Wireless Connectivity Option" on page 42).

---

## HILLROM READYCONNECT SYSTEM

The Hillrom **ReadyConnect** System is an accessory that provides communication between enabled **Centrella** Smart+ beds and a compatible nurse call system without the need for a 37-pin cable. The Hillrom **ReadyConnect** System also supports a 37-pin cable connection for beds that do not have a cable free option. Refer to the *Hillrom ReadyConnect Instructions for Use and Service Manual* (217064) for more information.

---

## VOALTE NURSE CALL SYSTEM

The **Voalte** Nurse Call System is an enterprise system that connects and monitors Hillrom beds and mattresses. The system sends bed and mattress data to the network applications for caregivers to view and receive alerts. For complete operational instructions for the **Voalte** Nurse Call System, refer to the **Voalte** Nurse Call System User Manual.

---

## WATCHCARE INCONTINENCE MANAGEMENT SYSTEM

The **WatchCare** Incontinence Management System option provides a discreet visual alert and optional equipment call alerts after moisture is detected on the **WatchCare** smart pad. Refer to the **WatchCare Incontinence Management System Instructions for Use and Service Manual** (196414) for more information.

---

## SMARTCARE REMOTE MANAGEMENT

**SmartCare** Remote Management is a secure cloud-based portal for centralized remote management of Hillrom beds and devices. **SmartCare** Remote Management gives Biomedical Engineers and/or Hillrom Service Technicians access to manage devices remotely with features including the following:

- Remote update configuration
- Remote upgrade asset firmware
- Remote asset location tracking
- Remote error code notification

---

## GRAPHICAL CAREGIVER INTERFACE (GCI) CONTROLS

The **Graphical Caregiver Interface (GCI)** (touchscreen) is on the **left** head siderail. Some models have the touchscreen on both head siderails.

Through the touchscreen, you can—

- View helpful information for the bed functions.
- Set the Bed Exit, **SafeView+** Alerts option, and <30° Head Limit.
- Zero the scale.
- Weigh the patient.
- Adjust the **Centrella** max mattress settings (Turn Assist, Comfort, and Max Inflate).
- Turn on or off the **MCM** feature for the pro+ mattress.
- Adjust the touchscreen's date and time.
- Adjust the bed.
- View service information.
- Change the bed settings.



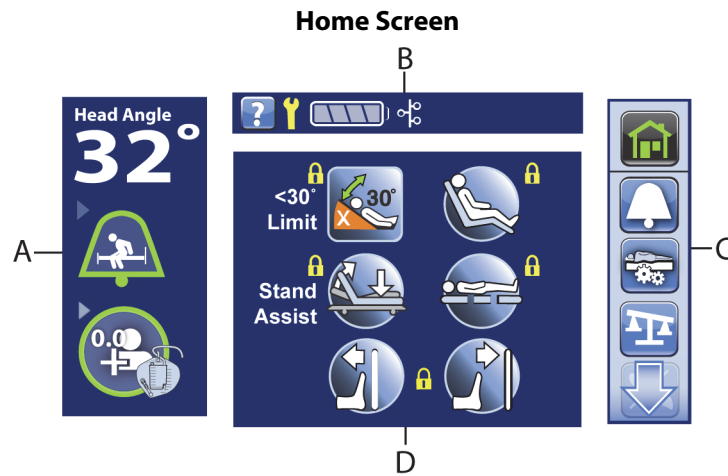

Item	Description	Item	Description
A	Status indicators	C	Menu list
B	Information indicators	D	Bed controls

**To Activate**—touch the screen. The Home screen will show. The screen will dim after 1 minute of no activity. After 3 minutes of no activity, the status screen shows (see “Status Screen” on page 45).

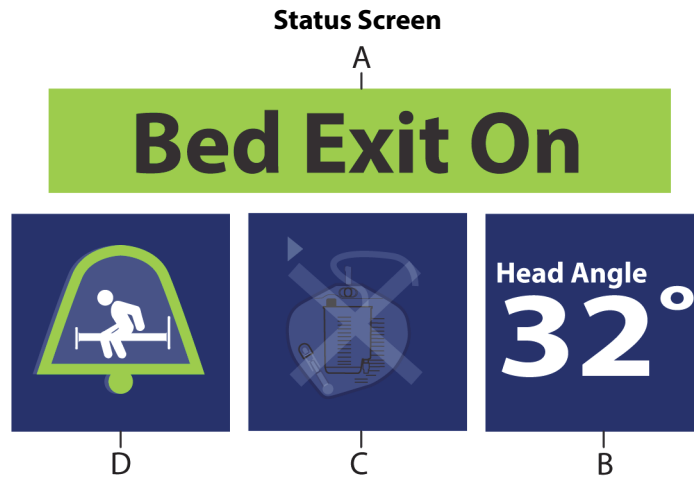

Item	Description	Item	Description
A	Bed Exit Status	C	Foley Limit indicator
B	Head Angle	D	Bed Exit indicator

The color on the upper border of the screen indicates these:

- Orange = warning
- Yellow = caution
- Blue = instructions or information
- Green = task was successful

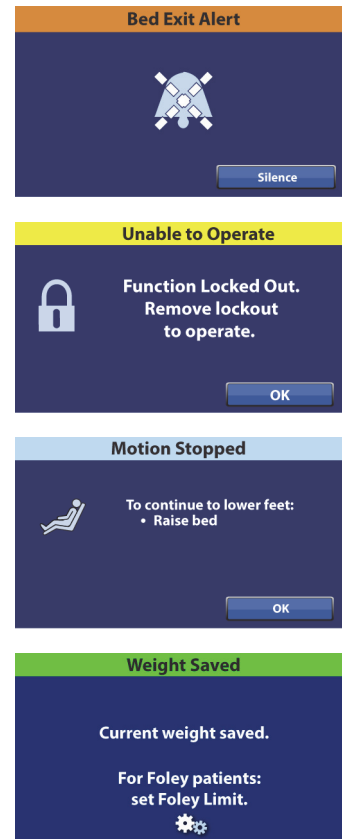

**NOTE:**

If a triple beep sounds, look at the touchscreen and follow the on-screen instructions.

**USE THE TOUCHSCREEN MENU CONTROLS**



**WARNING:**

**Warning**—Use care when you use the touchscreen menu controls, pressing a control inadvertently may cause unexpected bed movement that may cause patient injury.

As you use the touchscreen’s menu controls and view the different screens, you can press the **Home** menu control to return to the Home screen.

To view additional menu controls, use the **Up** and **Down** arrow controls.



To see more detail associated with the Status indicators that are on the left side of the screen, touch the applicable indicator.



## HELP (?) MENU

Through the Help menu control, you can access additional instruction for many of the bed functions and features.

1. Press the **Help** control on the touchscreen.



2. Press the control for the subject that you want to view.

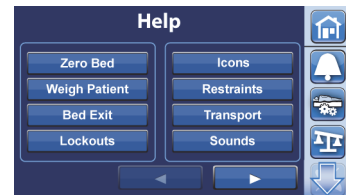

## HEAD ANGLE <30° LIMIT

The **<30° Limit** control allows the caregiver to prevent the head of the bed to be lowered below 30°.



### To Activate

1. Raise the head section to the desired position **above** 30°.
2. Press the **<30° Limit** control. A beep will sound and a green indicator light next to the <30° Limit control will come on to let you know that this feature is active.

### NOTE:

If a triple beep sounds and an error screen shows, follow the on-screen instructions.

## DINING CHAIR POSITION



### WARNING:

**Warning**—For patient and equipment safety, make sure to monitor the patient and all patient interface lines during articulation. Failure to do so could cause injury or equipment damage.



### CAUTION:

**Caution**—Do not transport a patient with the bed in the **Dining Chair** position. Equipment damage could occur.

**Caution**—When you use the Chair control, lower the bed, or use the Reverse Trendelenburg control, make sure that the drainage bags do not touch the floor. Remove them if necessary. Follow facility protocol if the drainage bags touch the floor.

This feature allows the caregiver to adjust the bed to a reclined chair position. When you press the chair control, the bed will articulate the head section to its highest position, the knee section to its highest position, and the foot section to its lowest position.



### NOTE:

The bed will not articulate into the **Dining Chair** position if any of the frame controls are locked out or if the bed is operating on battery power.

### To Activate

1. Set the brake.
2. Press and hold the **Chair** control. The bed transitions into the reclined position.
3. When the bed has reached the desired position, release the Chair control. To put the bed into an additional upright chair position, raise the bed height and use the Reverse Trendelenburg control.

### NOTE:

If the bed is equipped with the Foley Position Limit and the feature is on, this can limit the chair position. See "Foley Position Limit" on page 74.

## STAND ASSIST

The Stand Assist control raises the head section and lowers the knee section to help the patient more easily exit the bed. If a **Centrella** max mattress is on the bed, the seat section of the mattress inflates to provide additional support. After 15 minutes, this feature times out and the mattress will return to the previous setting.



### To Activate

1. Press and hold the **Stand Assist** control until the legs are flat and the head is at the desired head angle.
2. Help the patient move to side sit at the edge of the mattress.
3. If a **Centrella** max mattress is on the bed, wait for the seat section to inflate to provide more support for the patient.
4. Adjust the bed height so the patient's feet are flat on the floor, and then help the patient out of the bed.

### NOTE:

After 15 minutes, the **Centrella** max mattress will return to the previous setting.

## BED FLAT

The **Bed Flat and Level** control returns the bed, head, and knee to the flat and level position (head and knee sections down, and foot section up if it is down) from any articulated position.



**To activate**—press and hold the **Bed Flat and Level** control until the system stops its articulations. You will hear a single beep when the bed is at its flat position.

### NOTE:

If any frame function is locked, the Bed Flat and Level control will not operate, an audible alert will sound, and a message will show on the touchscreen.

## FLEXAFOOT BED LENGTH ADJUSTMENT



### WARNING:

**Warning**—Do not adjust the bed when traction equipment is in use. To do so could cause personal injury or equipment damage.

The caregiver can extend a powered foot section up to 12" (30 cm) to accommodate various patient heights. During adjustment, the foot section can be stopped in the fully retracted or extended position, or at any distance between the two.

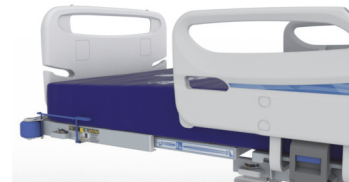

**To lengthen**—press and hold the **Foot Longer** control until the foot section is at the desired length.

**To shorten**—press and hold the **Foot Shorter** control until the foot section is at the desired length.



## BED EXIT ALERT SYSTEM

### Bed Exit Mode Descriptions

The Bed Exit Alert system has three levels of sensitivity settings to select from:

- **Position Mode**—this mode alerts when the patient changes position. This mode should be used when a caregiver wants to be notified when the patient begins to move.
- **Exiting Mode**—this mode alerts when the patient moves away from the center of the bed towards the edge of the bed. This mode should be used when a caregiver wants to be notified when a potential bed exit is attempted.
- **Out of Bed Mode**—this mode alerts when the patient's weight has left the bed. This mode should be used when a caregiver wants the patient to move freely within the bed, but to be notified when the patient leaves the bed.



**NOTE:**

Only one Bed Exit mode can be active at a time.

**To Activate**

1. Make sure the patient is centered on the bed and aligned with the hip locator on the siderail.
2. Press the **Alerts** menu control.
  
3. Press one of these modes:
  - Changes position.
  - Moves towards edge.
  - Has left the bed.

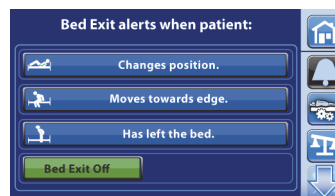

When the system beeps one time and the Bed Exit On indicator shows on the Home screen, the system is armed.



**To Deactivate the Alert**

1. Press the **Alerts** menu control.
  
2. Press **Bed Exit Off**.
  
3. Press **Bed Exit Off**.

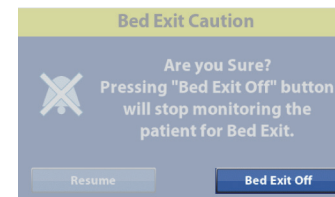
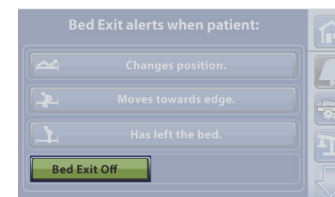

At the Home screen, the Alert Status indicator shows an "X", the alert icon is no longer green, and shows "Exit Alert Off" for 10 seconds.





## To Silence the Bed Exit Alert without Deactivating the System

When a Bed Exit mode is armed, you can silence the alert system. During this Silence mode, the system stops monitoring the patient movements; therefore, **the system will not notify the care team or cause an alert**. While the system is in the Silence Mode, you can change the position of the patient or assist the patient out of the bed. You can silence the alert before it sounds (preemptively) or after it sounds.

### To Activate the Preemptive Alert Silence

Press the **Silence** control on the caregiver controls until the indicator light next to the control is **on**.



### NOTES:

- For the Position and Exiting modes, center the patient in the bed before you resume the Bed Exit monitoring.
- For the Out of bed mode, the bed will resume the Bed Exit monitoring when the patient gets in the bed.

### To Silence a Bed Exit Alert

1. Press the **Silence** control on the siderail caregiver controls until the indicator next to the control is on or press **Silence** on the touchscreen.

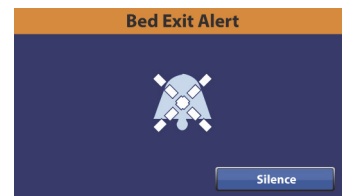

2. Press the applicable option:

- **1 Minute or 5 Minutes**—if a 30 second silence period is not long enough, select 1 or 5 Minutes to add time.

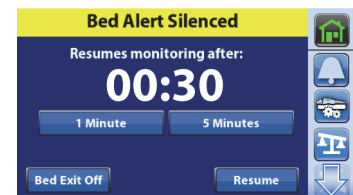

While silenced, if the patient exits the bed, the alert will not sound.

After the patient has returned to the bed, the Bed Exit Alert will attempt to re-arm in the previously set mode. The Bed Exit Alert will attempt to re-arm when the patient sits on the bed. The system will not be able to re-arm in the Exiting or Position Modes unless the patient is in the center of the bed.

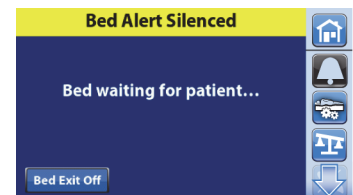

- **Resume**—immediately turns the Bed Exit Alert on.
- **Bed Exit Off**—turns the Bed Exit Alert off. The touchscreen will prompt you to confirm that you want to turn off and stop monitoring the patient for Bed Exit.

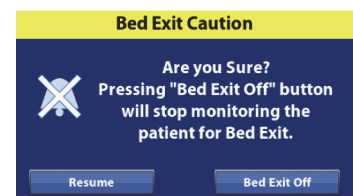

**NOTES:**

- If you finish the task before the silence timer has expired, press Resume to reactivate the Bed Exit Alert. Do not leave the patient unattended until Resume is pressed, and the Bed Exit system is reactivated. The Bed Exit Alert will not be active and will not convey its status until it has been reactivated or the timer has run out.
- A low volume repeating triple beep will occur every 10 seconds to remind you that the Bed Exit is silenced and should be resumed before you leave the room.
- For the Position and Exiting modes, center the patient in the bed before you resume the Bed Exit monitoring.
- For the Out of Bed mode, the bed will resume the Bed Exit monitoring when the patient sits in the bed.

**SCALE**

There are two scale systems available for the bed. Scale System **A** has an operating range of 0 kg to 227 kg (0 lb to 500 lb). Scale System **B** (NAWI Compliant EN 45501) has an operating range of 10 kg to 250 kg (22 lb to 551 lb). The controls for the scale systems are under the Scale menu control.

Refer to the images and page numbers shown below to determine which instructions apply to your scale system:

**Scale A**

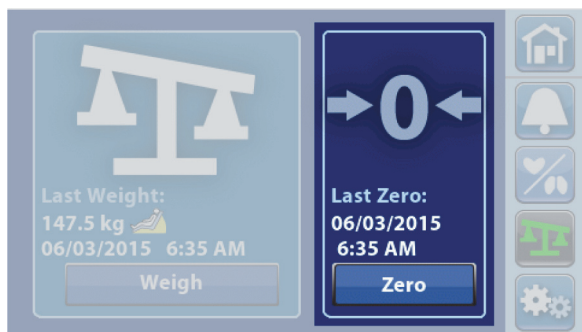

Refer to page 52.

**Scale B—NAWI Compliant EN 45501**

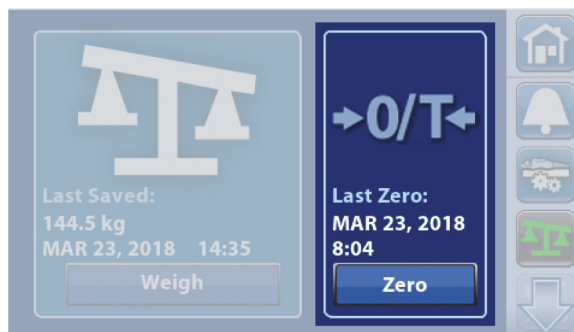

Refer to page 58.

**Scale “A”**

Through the Scale menu control you can do these:

- Zero the scale.
- Weigh the patient.
- Temporarily view the weight in pounds (lb).
- View the current patient’s weight, previous weight, and the difference between the two.



**WARNING:**

These warnings apply to both zero the scale and weigh procedures. To help prevent injury and/or equipment damage, obey these **warnings**:

- **Warning**—The scale is very sensitive. Make sure the bed is not touching anything that could affect the patient weight (other beds or carts, headwall, miscellaneous drainage lines, etc.) while the bed is in the **zeroing or weighing** process. Failure to do so could cause an inaccurate weight reading.
- **Warning**—Always use the **New Patient** zero before a patient is admitted into the bed. Failure to do so may keep old patient data in the bed and cause a risk to the new patient.

**NOTES:**

These notes apply to both zero the scale and weigh procedures:

- The scale will only work when the bed is connected to AC power.
- The equipment in the foot-end sockets **will** be included in the Zero and patient Weigh processes.
- Everything on or attached to the articulating upper frame and siderails **will** be included in the Zero and patient Weigh processes.
- The headboard and devices mounted to the head end of the bed **will not** be included in the Zero and patient Weigh processes.
- Zero scale Reminder and patient Weigh Instructions screens will show to instruct you to check items to be included in the scale reading.

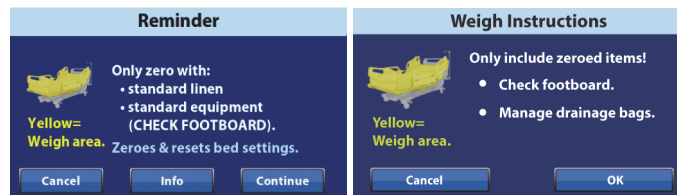
**To Zero the Scale**Required Bed Position to Zero the Scale

The required bed position is as follows:

- Bed level
- Head angle <35° (bed Zero only)
- Knee angle <25°
- Foot angle <10°

If the bed is not in the required bed position to zero the scale, a Not in Required Position screen will show on the touchscreen. Press the **Adjust Bed Button** on the touchscreen or use the caregiver or patient controls to adjust the bed to the required position.

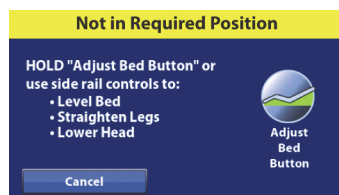

There are two ways to zero the scale:

- **New Patient**—this is used before you admit a new patient into the bed. New Patient will clear the patient history, zero the scale, and reset all settings to the facility's default settings.
- **Same Patient Re-Zero**—this is used when you want to add equipment to the bed during a patient's stay and not have it included with the patient weight, or if you are getting inconsistent weight readings when you weigh a patient. Re-Zero will zero the scale and keep the patient's history. Re-Zero will not reset the **SafeView+** Alerts option or Bed Exit Alert.

**NOTE:**

Always make sure there is **not a patient** on the bed when you zero the scale.

**Setup**

1. Make sure the bed is plugged into AC power.
2. Put all standard linens, blankets, pillows, and the patient pendant on the bed. A list of these items posted near the bed may be helpful for future reference.
3. The scale is very sensitive. Make sure the bed is not touching anything that could affect the patient weight (other beds or carts, headwall, miscellaneous drainage lines, etc.).
4. Make sure the patient is not on the bed.
5. Put the bed in the required bed position to zero the scale. See "To Zero the Scale" on page 53.
6. Press the **Scale** menu control.
7. Press **Zero**.



New Patient (Zero)

Use New Patient zero every time a new patient is admitted to the bed.

The New Patient control will—

- Clear the previous and current weight history
- Zero the scale
- Reset these features:
  - Bed Exit Alert to off
  - **SafeView+** Alerts option to the default protocol
  - HR and RR monitoring data
  - Audible indicator to the default protocol
  - Alert setting to the default protocol
  - Head <30° Limit to off
  - Frame lockouts to off
  - Comfort settings to Normal

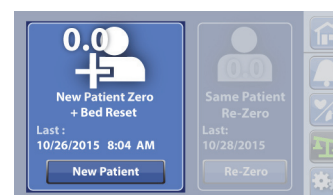

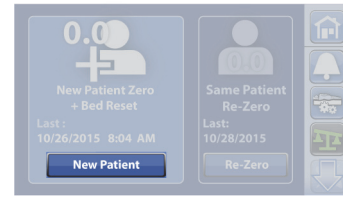
1. Press **New Patient**.

## 2. A reminder message shows. Follow the on-screen instructions.

**NOTES:**

- Remove everything attached to the upper frame, siderails, and foot end of the bed or the items **will be** included in the patient's weight.
- The headboard and devices mounted to the head end of the bed **will not** be included in the patient's weight.
- **Cancel** will return the touchscreen to the previous screen.



## 3. The touchscreen will show that the bed is zeroing. Do not touch the bed while the bed zeroes.

**NOTES:**

- If the "Not In Required Position" screen shows, press the Adjust Bed Button on the touchscreen.
- If the "Difference from Last Zero" caution screen shows, re-check the bed for items that should be included during the zero.
- The scale will not zero if there is more than a 45 kg (99.2 lb) weight difference from the last zero. This is to reduce the possibility of zeroing the scale with a patient in the bed.

4. A single beep will sound, and the touchscreen will show that the bed is ready for a new patient. To return to the **Home** screen, touch the screen or place a patient in the bed.

To learn more about the Foley Position Limit, see "Foley Position Limit" on page 74.

Re-Zero (Same Patient)

Use Re-Zero whenever you add equipment or other items to a bed that previously has been zeroed for the patient. An example of this would be if you replace a mattress with a heavier mattress or if there are inconsistent weight readings. Before you press Re-Zero, make sure that the patient is not in the bed.

The Re-Zero control will—

- **Not** reset the bed settings.
- Zero the Scale for the Same Patient (does not clear the history).

1. Press **Re-Zero**.

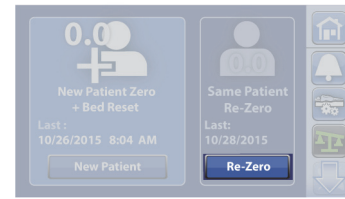

2. A reminder message shows. Follow the on-screen instructions, and press **Continue**.

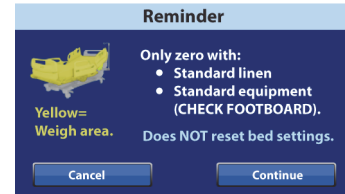

**NOTE:**

**Cancel** will return the touchscreen to the previous screen.

3. The touchscreen will show that the bed is zeroing. Do not touch the bed while the bed zeroes.

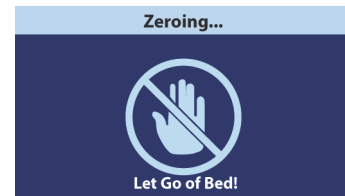

**NOTES:**

- If the “Not Required Position” screen shows, press the Adjust Bed Button on the touchscreen.
- If the “Difference from Last Zero” caution screen shows, re-check the bed for items that should be included during the zero.
- The scale will not zero if there is more than a 26 kg (57.3 lb) weight difference from the last zero. This is to reduce the possibility of zeroing the scale with a patient in the bed.

4. A single beep will sound, and the screen will show that the Re-Zero is complete.

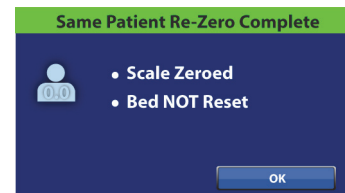

## To Weigh the Patient

### Required Bed Position to Weigh the Patient

The required bed position is as follows:

- Bed level
- Knee angle <25°
- Foot angle <10°

If the bed is not in the required bed position to weigh the patient, a Not in Required Position screen will show on the touchscreen. Press the **Adjust Bed Button** on the touchscreen or use the caregiver or patient controls to adjust the bed to the required position.



1. Center the patient on the bed.
2. Press the **Scale** menu control.



3. Press **Weigh**.

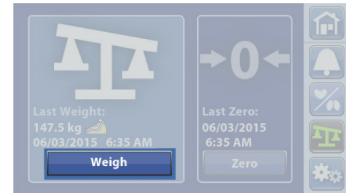

4. Weigh Instructions will show on the touchscreen. Follow the instructions, and then press **OK**.

**NOTES:**

- Remove everything attached to the upper frame, siderails, and foot end of the bed or the items **will be** included in the patient's weight.
- The headboard and devices mounted to the head end of the bed **will not** be included in the patient's weight.
- **Cancel** will return the touchscreen to the previous screen.



5. Make sure not to touch the bed as the scale weighs the patient.



**NOTE:**

If the bed is in the required position but not in the best position to weigh, the Not in Optimal Position screen may show. You may weigh the patient in this position, but the accuracy of the measured weight is reduced. You may use the Adjust Bed Button to put the bed In Optimum Position.



To see the current weight, last weight, and weight difference in the non-primary scale unit, press and hold the **lb** (or **kg**) control.

**NOTE:**

The default primary scale unit is measured in kg. Contact your authorized maintenance persons to do these—

- Change the primary scale unit to lb.
- Disable or enable the ability to view the alternative scale unit.



6. When the current weight screen shows, you have the option to Save or Re-Weigh:

- **Re-Weigh**—bed will repeat the steps to weigh the patient
- **Save**—stores the weight



**NOTES:**

- A warning statement will show on the screen if the scale system detects a weight that is less than the intended minimum patient weight (70 lb, 32 kg). See the warning below:



**WARNING:**

**Warning**—The intended patient range is 70 lb (32 kg) to 500 lb (227 kg). Use of the bed with patients outside the intended patient weight may increase the risk of entrapment or asphyxiation and/or loss of therapeutic value. Use of the bed with patients above the bed’s intended maximum patient weight may also cause damage the bed.

- This yellow symbol shows that the weight was taken when the bed was Not In Optimum Position.



When the weight is saved, a beep will sound, and a confirmation screen will show.



**Scale “A” Specifications**

Scale accuracy: 0.5 kg (1.1 lb) or 0.5% of the patient weight, whichever is greater, when the bed is **in the required bed position**.

Scale accuracy: 1.0 kg (2.2 lb) or 1% of patient weight, whichever is greater, when the bed is **Not In Optimum Position**.

**Scale “B” —NAWI Compliant (EN 45501)**

Some beds are equipped with the NAWI scale. You can tell if your bed is equipped with the NAWI scale by these:

- The scale screen shows “0/T” above the Zero control.
- The weigh screen shows a magnifying glass.

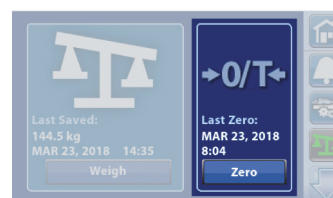



Through the Scale menu control you can do these:

- Zero the scale.
- Weigh the patient.
- View the current patient’s weight, previous weight, and the difference between the two.
- Add items that should be included or remove items that should not be included in the patient weight measurement.



### Non-Verified Weight

A Non-Verified Weight is a live weight reading of the patient and all items on the weighing area that are not zeroed/tared out of the measurement.

To verify the weight, remove the items on the weigh area that are not zeroed/tared, and press **Verify**.



If the scale reading shows dashes, the scale is unable to weigh the patient. This may occur when—

- The bed weighs below -0.25 kg.
- The bed weighs above 254.5 kg.
- The measured weight is unstable.



If the measured weight is unstable, make sure the patient and bed are not moving.

Remove the patient from the bed. If this does not fix the problem, contact your facility-authorized maintenance person.

Make sure the pendant is either on the siderail or bed when you zero the scale or weigh a patient.

### To Zero/Tare the Scale

#### Required Bed Position to Zero the Scale

The required bed position is as follows:

- The bed in the highest position.
- The bed fully flat.

If the bed is not in the required bed position to zero the scale, the Not in Required Position screen will show on the touchscreen. Press the **Hold to Adjust** control on the touchscreen or use the caregiver or patient controls to adjust the bed to the required position.

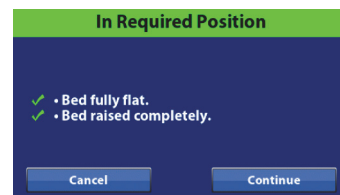

There are two ways to zero the scale:

- **Zero (New Patient)**—this is used before you admit a new patient into the bed. New Patient will clear the patient history, zero the scale, and reset all settings to the facility’s default settings.
- **Re-Zero (Same Patient)**—this is used when you want to add equipment to the bed during a patient’s stay and not have it included with the patient weight, or if you are getting inconsistent weight readings when you weigh a patient. Re-Zero will zero the scale and keep the bed settings.

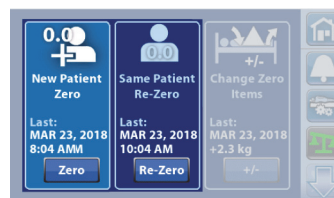

**NOTE:**

Always make sure there is **not a patient** on the bed when you Zero or Re-Zero the scale.

**Setup**

1. Make sure the bed is plugged into AC power.
2. Make sure the bed is in the required position for Zero. See “Required Bed Position to Zero the Scale” on page 59.
3. Put all standard linens, blankets, pillows, and the patient pendant on the bed. A list of these items posted near the bed may be helpful for future reference.
4. The scale is very sensitive. Make sure the bed is not touching anything that could affect the patient weight (other beds or carts, headwall, miscellaneous drainage lines, etc.).
5. Make sure the patient is not on the bed.
6. Press the **Scale** menu control.



7. Press **Zero**.



Zero (New Patient)

Use Zero every time a new patient is admitted to the bed.

The Zero control will—

- Clear the previous and current weight history
- Zero the scale

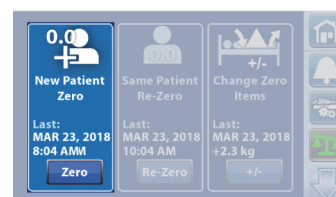

- Reset these features:
  - Weight history
  - Bed Exit Alert to off
  - **SafeView+** Alerts option to the default protocol
  - Audible indicator to the default protocol
  - Alert setting to the default protocol
  - Head <30° Limit to off
  - Frame lockouts to off
  - Comfort settings to Normal

1. Press **Zero**.

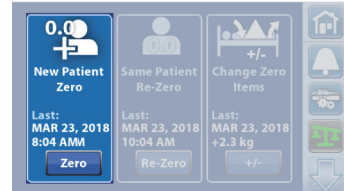

2. A reminder message shows. Follow the on-screen instructions, and press **Continue**.

**NOTES:**

- **Cancel** will return the touchscreen to the previous screen.
- **Info** will show what bed features will be reset if you continue to Zero.

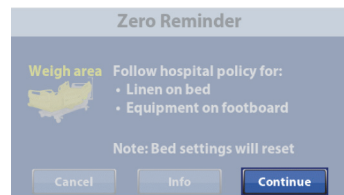

3. The touchscreen will show that the bed is zeroing. Do not touch the bed while the bed zeroes.

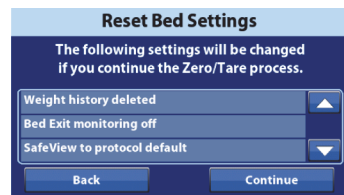

**NOTE:**

If the "Not In Required Position" screen shows, press the **Hold to Adjust** control on the touchscreen.



4. A single beep will sound, and the touchscreen will show that the bed is ready for a new patient. To return to the **Home** screen, touch the screen or place a patient in the bed.



To learn more about the Foley Position Limit, see "Foley Position Limit" on page 74.



## Re-Zero (Same Patient)

Use Re-Zero whenever you add equipment or other items to a bed that previously has been zeroed for the patient. An example of this would be if you replace a mattress with a heavier mattress or if there are inconsistent weight readings. Before you press Re-Zero, make sure that the patient is **not** in the bed.

The Re-Zero control will—

- **Not** reset the bed settings.
- Zero the Scale for the Same Patient (does not clear the history).

1. Press the **Scale** menu control.



2. Press **Zero**.



3. Press **Re-Zero**.

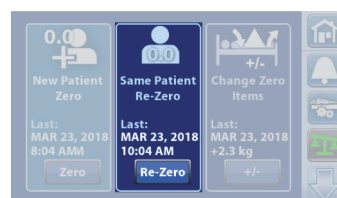

4. A reminder message shows. Follow the on-screen instructions, and press **Continue**.

### NOTE:

**Cancel** will return the touchscreen to the previous screen.



5. The touchscreen will show that the bed is zeroing/taring. Do not touch the bed while the bed zeroes/tares.



### NOTES:

- If the “Not Required Position” screen shows, press the Hold to Adjust control on the touchscreen.
- If the “Difference from Last Zero” caution screen shows, re-check the bed for items that should be included during the zero.
- The scale will not zero if there is more than a 26 kg weight difference from the last zero. This is to reduce the possibility of zeroing the scale with a patient in the bed.

- A single beep will sound, and the screen will show that the Re-Zero is complete.

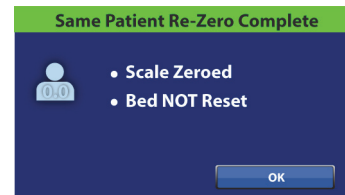

### +/- (Change Zero Items)

The +/- control allows you to manually change the weight for items added to or removed from the bed to correct the patient weight while the patient is on the bed.

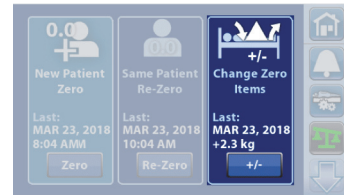

### **NOTE:**

If the patient is not on the bed, use the **Re-Zero** control.

Before you add or remove items, use the +/- control to keep the patient weight. Then, add an item to or remove an item from the bed so the item is not included in the patient weight measurement.

- Press the **Scale** menu control.



- Press **Zero**.



- Press +/-.

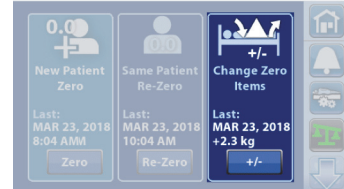

- Follow the on-screen instructions, and press **Weigh**.

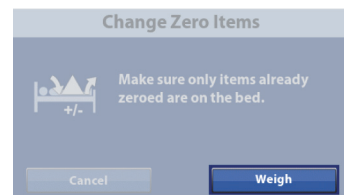

- After the bed is done weighing, add or remove the items, and press **Continue**.

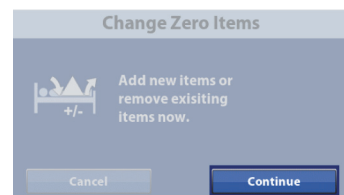

- After the bed is done weighing, a Change Zero Complete screen will show, press **OK**.



After the scale is zeroed/tared, and the empty bed is in a stable position, a green indicator with +/- 0,25 e Zero/Tare will show on the Weigh screen. This indicates the bed has an acceptable zero/tare. The indicator will no longer show when weight is on the bed or if there is an unstable equilibrium +/- 0,25 e Zero/Tare.



If the empty bed has been zeroed/tared, is in a stable position, and the indicator is not on, re-zero/tare the bed.

## To Weigh the Patient

### Optimum Bed Position to Weigh the Patient

The optimum bed position is as follows:

- The bed in the highest position.

If the bed is not in the optimum bed position to weigh the patient, a Not in Optimum Position screen will show on the touchscreen. Press the **Hold to Adjust** control on the touchscreen or use the caregiver or patient controls to adjust the bed to the optimum position.

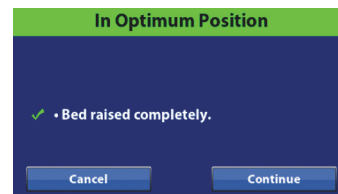
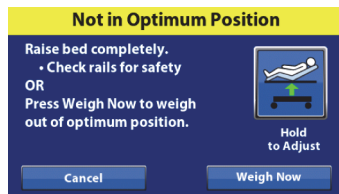

- Center the patient on the bed.
- Press the **Scale** menu control.



- Press **Weigh**.



- The Non-Verified Weight will show, press **Verify**.



**NOTE:**

The Magnification Mode will change the scale display increments to 0.1 kg for 5 seconds. The weight cannot be saved in the Magnification Mode.

5. Weigh Instructions will show on the touchscreen. Follow the instructions, and then press **OK**.

**NOTES:**

- Remove everything attached to the upper frame, siderails, and foot end of the bed that has not been zeroed or the items **will be** included in the patient’s weight.
  - The headboard and devices mounted to the head end of the bed **will not** be included in the patient’s weight.
  - **Cancel** will return the touchscreen to the previous screen.
6. Make sure not to touch the bed as the scale weighs the patient.



7. When the current weight screen shows, you have the option to Save or Re-Weigh:

- **Re-Weigh**—bed will repeat the steps to weigh the patient
- **Save**—stores the weight

**NOTES:**

- Red text will show if the measured weight is more than 2.0 kg difference from the Non-Verified Weight.
- Yellow text will remind you to check for items on the bed, and if you would like to re-weigh.
- This yellow symbol shows that the weight was taken when the bed was Not In Optimum Position.
- A warning symbol will show on the screen if the scale system detects a weight that is less than the intended minimum patient weight 32 kg.



When the weight is saved, a beep will sound, and a confirmation screen will show.

## Scale “B” Specifications

Class III

e=0.5 kg

Conforms to the European Medical Device Directive 93/42/EEC for a device that has a measuring function. The scale is classified per Scale Directive 2014/31/EU.

Maximum weight: 250 kg

Minimum weight: 10 kg

Display intervals: 0.5 kg

Combined zero and tare range: 10 kg to 250 kg

The maximum scale capacity is 250 kg; however, the maximum patient weight for the bed is 227 kg.

### To Troubleshoot Scale Messages

**Weight Limit Issue** (weigh problem)—this message shows when the scale system cannot weigh because the weight is more than 500 lb (227 kg).

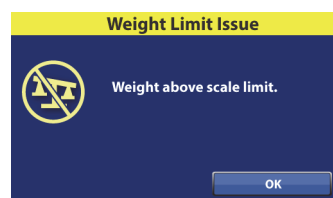

**Weight Limit Issue** (weigh problem)—this message shows when the scale system cannot weigh because the weight is less than zero. Re-zero the bed with the bed empty and the correct items on the bed.

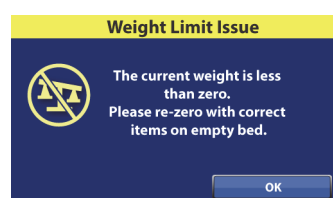

#### **NOTE:**

If you are certain that the patient weight is within the **70 lb to 500 lb** (32 kg to 227 kg) range, zero the scale (see “To Zero the Scale” on page 53), and then weigh the patient.

**Weight Not Saved** (weigh problem)—this message shows if the weight was not saved. Press **Back**, and then press **Save**.



**Scale Error** (Scale “A”; bed movement problem)—this message shows when the scale system detects movement of the bed or the patient. Do not adjust or move the bed, have the patient lay still, and then press **OK**.

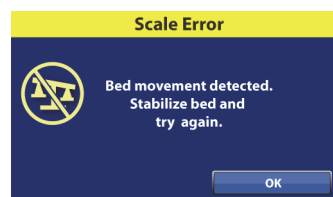

**Unstable Weight Error** (Scale “B”; bed movement problem)—this message shows when the scale system detects movement of the bed or the patient. Do not adjust or move the bed, have the patient lay still, and then press **OK**.

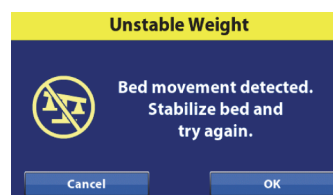



**NOTE:**

The scale will not function if bed motion is detected. Keep the bed still while zeroing or weighing.

**Not in Required Position** (Scale “B”)—this message shows when the bed is not in the required position to zero the scale. Press the **Hold to Adjust** control on the touchscreen or use the caregiver or patient controls to adjust the bed to the required position.



For Required Bed Position, put the bed fully flat in the highest position.

**Not in Optimum Position** (Scale “B”)—this message shows when the bed is not in the optimum position to weigh. Press the **Hold to Adjust** control on the touchscreen or use the caregiver or patient controls to adjust the bed to the optimum position.

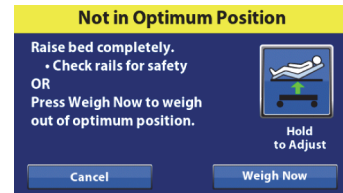

For the Optimum Position, put the bed fully flat in the highest position.

The bed will weigh the patient even if the bed is not in the optimum position when you press Weigh Now.

**Not in Required Position** (Scale “A”)—this message shows when the bed is not in the required position to zero the scale. Press the **Adjust Bed Button** on the touchscreen or use the caregiver or patient controls to adjust the bed to the required position.

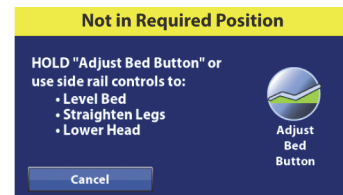

The Required Bed Position—

- Bed level
- Head angle <35°
- Knee angle <25°
- Foot angle <10°

**Unable to Operate** (lockout error)—this message shows when the Adjust Bed Button (Scale “A”) or Hold to Adjust (Scale “B”) is pressed while a bed control is locked out. The bed is unable to adjust to the correct position. Press **OK**, and then do as follows:

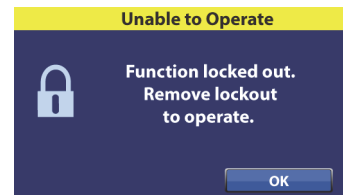

1. Unlock the bed control(s).
2. Put the bed in the correct position.
3. Continue to Zero the scale or Weigh the patient.

**Unable to Operate: Level Bed** (Scale “B”; scale zero error)—this message shows when the bed is not level to zero or re-zero the scale. Press **OK**, and then do as follows:

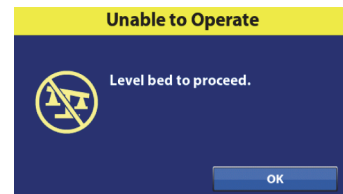

1. Use the Trendelenburg control to level the bed.
2. Continue to Zero the scale.

**NOTE:**

**Error** (technical problem)—this message shows when a scale load beam does not operate as intended. Contact your authorized maintenance persons.

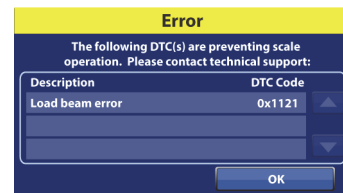

## SETTINGS/PREFERENCES

Through the **Settings** menu control, you can—

- Set these bed features: **SafeView+** Alerts option Floor Projections, Siderail Lights, Siderail Protocol, USB Charging Port, Voice Alerts, and Mattress Features.
- Adjust the touchscreen brightness.
- Set the Foley Limit feature.
- Adjust the time zone, time, and date (only beds with the NAWI Compliant (EN 45501 scale).
- Update the bed software.



### NOTES:

- Not all bed models are equipped with the features listed above.
- The list on the right side is intended for service information. Only facility-authorized person should service the bed.
- To use the WiFi option, the bed must be connected to a wireless network. Contact your local service personnel

## Software Update

A software update is available for the bed when—

- A purple notification dot appears on the settings icon and the Software Update button.



OR



- The New Bed Software Available screen is shown on the GCI touchscreen. You have the option to Remind Me or Restart:
  - **Remind Me**—New Bed Software Available screen will appear again in 12 hours.
  - **Restart**—The bed will restart, and the new software will be available.



## SafeView+ Alerts Floor Projections Option—ON/OFF

Beds equipped with the **SafeView+** Alerts Floor Projections option show the bed's status at the foot end of the bed and project status indicators on to the floor. For more information about the **SafeView+** Alerts option, see page 26.

1. Press the **Settings** menu control.



2. Press **Bed Features**.

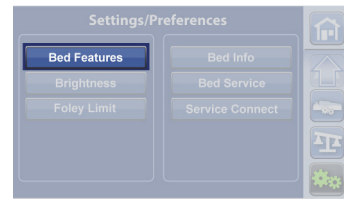

3. Press **SafeView**.



4. Press **Off** or **On** for the SafeView Floor Projections.

5. Press **Accept**.



### **IllumiGuide Siderail Handgrip (blue light only)—ON/OFF**

Beds equipped with the **IllumiGuide** siderail handgrip allow the patient to easily find the grip location on the siderail when the patient exits the bed. The light will stay on for 15 minutes after the patient exits the bed and 2 minutes after the patient returns to the bed.

1. Press the **Settings** menu control.



2. Press **Bed Features**.

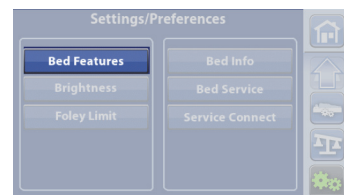

3. Press **Siderail Lights**.



4. Press **On** or **Off**.

5. Press **Accept**.

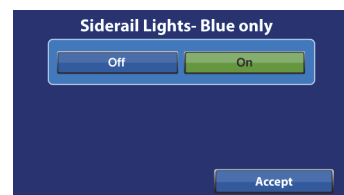

**NOTE:**

If **Off** is selected, the **IllumiGuide** siderail handgrip light will still show amber indications for the Bed Exit Alert status (alerting and silenced) if the feature has been armed.

## Siderail Protocol

Beds equipped with the **SafeView+** Alerts option show the status of the Siderail Protocol (green or amber) at the foot end of the bed. The Siderail Protocol allows you to set the siderail configuration for the patient's needs. If more siderails are down than the set siderail protocol, the siderail indicator will flash amber at the foot end of the bed.

1. Press the **Settings** menu control.



2. Press **Bed Features**.



3. Press **Rail Protocol**.



4. Select the patient siderail protocol. A green check shows when the siderail is being monitored.

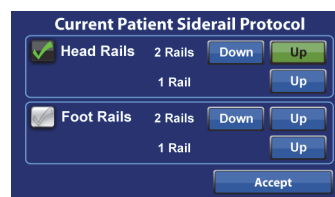

5. Press **Accept**.

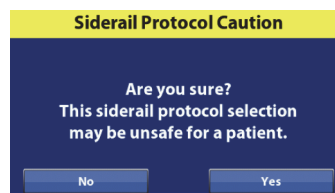

### NOTE:

Some rail combination settings may be unsafe for some patients. A message may show on the touchscreen to confirm your selection.

## USB Charging Port—On/Off

The USB charging port is on the right-head siderail.

1. Press the **Settings** menu control.



2. Press **Bed Features**.

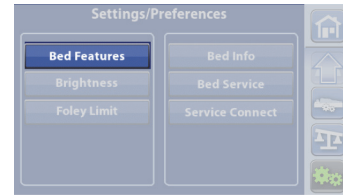

3. Press **USB**.



4. Press **Off** or **On**.
5. Press **Accept**.

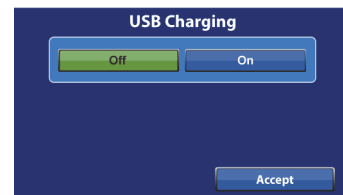

## Voice Alerts

Beds equipped with the Voice Alerts feature provide audible messages through the siderail speakers to provide guidance to the patient or caregiver. You may select English, Spanish, or French for the voice alerts. For more information about Voice Alerts, see page 14.

1. Press the **Settings** menu control.



2. Press **Bed Features**.



3. Press **Voice Alerts**.



You have three options:

- All Alerts **Off**—turns all voice alerts off.
- All Alerts **On**—turns all voice alerts on.
- Individual Alerts Select—lets you turn off or on each individual voice alert.

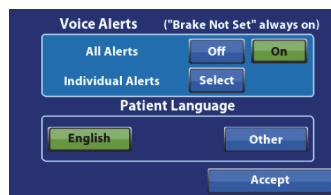

**NOTE:**

The “Brake Not Set” voice alert is always active even when All Alerts is set to Off.

4. Press the applicable option. If you press Select for Individual Alerts, press Off or On for each voice alert, and then press the back arrow to return to the previous screen.

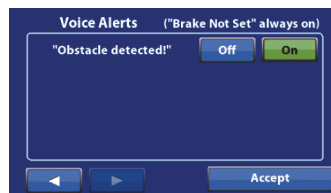
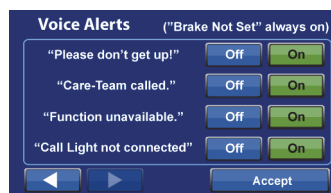

5. Select the patient’s language, and then press **Accept**.

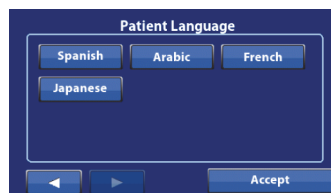
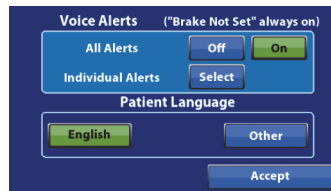

**Mattress Features**

Beds equipped with the pro+ mattress have the **Microclimate Management (MCM)** feature. The **MCM** menu control can be visible or hidden from the Home screen menu.

1. Press the **Settings** menu control.



2. Press **Bed Features**.

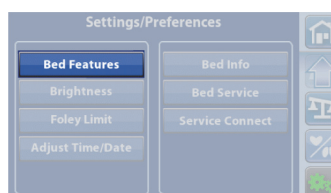

3. Press **Mattress Features**.



4. Press **Visible** or **Hidden**.
5. Press **Accept**.



**NOTE:**

The **MCM** Menu control will not show on the Home screen if Hidden is selected.



**Screen Brightness**

1. Press the **Settings** menu control.



2. Press **Brightness**.



3. Press - to decrease the brightness, or press + to increase the brightness.
4. Press **Accept**.

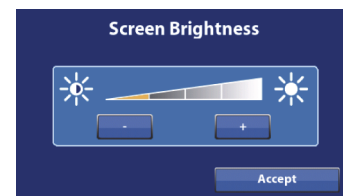

## Foley Position Limit

Beds equipped with Foley Position Limit restrict how much the foot section can lower to reduce the likelihood of a drainage bag touching the floor.

1. Press the **Settings** menu control.



2. Press **Foley Limit**.



3. Press **Off** or **On**.

4. Press **Accept**.

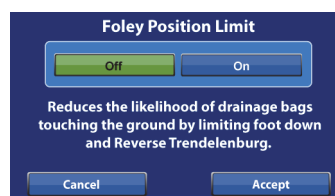

5. A confirmation screen will show that the Foley Position Limit is set. If a triple beep sounds and an error screen shows, follow the on-screen instructions.

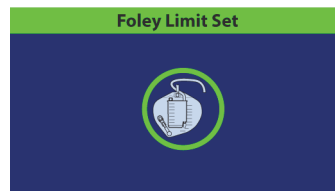

The Foley Limit indicator will show on the Home screen when the Foley Position Limit is on.



## BEDSIDE ASSOCIATION







The Bedside Association feature permits the caregiver to associate the bed to a room and patient through WiFi. You must have the **Hillrom** Digital Health Gateway version 1.2 or greater for this feature to operate. This feature uses the facility's electronic chart to associate a room and patient to the bed.

### NOTE:

This feature is enabled by a service/maintenance technician through the service menu on the touchscreen (per the facility's request).

The Room and Patient icons on the Home screen tell you the status of the association and also permits you to associate a room and patient to the bed.



Home Screen	Room/Patient Icons	Description
		No room associated; no patient verified
		Room associated; no patient verified <sup>a</sup>
		Room associated; patient verified
		No room associated; patient identification is off
		Room associated; patient identification is off

a. The Patient icon flashes when a patient is available from the gateway but has not yet been verified.

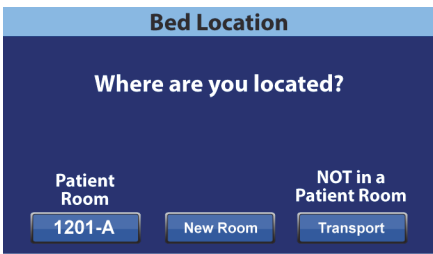
Transport Screens	Description
	When the bed is plugged in after being unplugged for less than five minutes, the room number will show on the screen for two minutes unless a control is pressed. If you press the "X," the room number window will close. If you press the room number, the Bed Location screen will show. See "Associate a Room to the Bed" on page 77.
	If the bed is plugged in after being unplugged for more than five minutes, the Bed Location screen will show and stay on the screen until the question is addressed. See "Associate a Room to the Bed" on page 77.

There are two ways to associate a room and its patient to the bed through the touchscreen:

- "Set Up the Bed Association through the Settings Menu" on page 75
- "Set Up the Bed Association Using the Room/Patient Icon" on page 77

### Set Up the Bed Association through the Settings Menu

1. At the Home screen, press the **Settings** menu control.



2. Press **Bed/Patient Locate**.

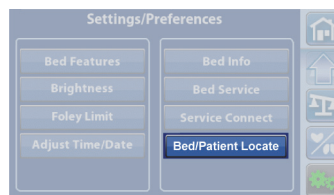

3. Make sure that the WiFi and Network icons are green. Then, press **Locate**.

**NOTE:**

Press Exit to return to the Home screen.

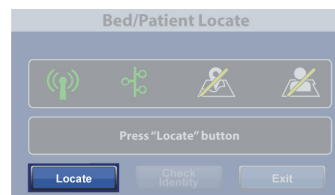

4. Select the correct options for the location, such as Building, Floor, and Room number.



**NOTES:**

- The location selection screens may have up to five levels of hierarchy: facility, building, unit, floor, and rooms. The Other Location control allows you to scroll through the available location levels.
  - You may see a “Retrieving data” screen as the bed gets the information from the Hillrom Digital Health Gateway.
5. One of two Bed Associated screens will show, depending on the facility’s preference. Do as applicable:

- Room location only—
  - Continue—press this control if the room number is correct. The Home screen will show with the Room Associated icon.
  - Change Room—press this control if the room number is not correct. The Available rooms screen will show (see Step 4).
- Room location and patient identity—
  - Continue—press this control if the room number is correct and you want to verify the patient identity. Go to “Verify the Patient Identity” on page 78.



- Cancel—press this control if you do not want to verify the patient identity. The Home screen will show with the Room Associated icon and flashing No Patient icon.
- Change Room—press this control if the room number is not correct. The Available rooms screen will show (see Step 4).

## Set Up the Bed Association Using the Room/Patient Icon

At the Home screen, press the **Room** or **Patient** icon, then do as applicable:

- If the Bed Location screen shows, a room association is in the bed's memory, go to "Confirm the Room to Bed Association" on page 78.
- If a location (such as Facility or Building) screen shows, a room is not in the bed's memory, go to "Associate a Room to the Bed" on page 77.

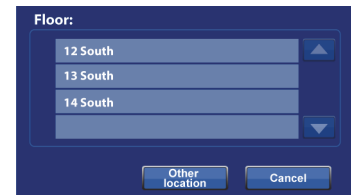
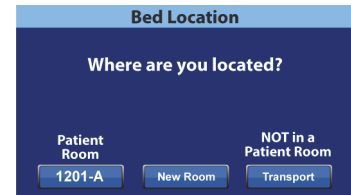

### Associate a Room to the Bed

1. Select the correct options for the location, such as Building, Floor, and Room number.

#### NOTES:

- On the Available rooms screen, press the Associated room's control, and a list of rooms that are associated to beds will show.
  - For all location selection screens, if you press Cancel, the Home screen will show.
  - The location selection screens may have up to five levels of hierarchy: facility, building, unit, floor, and rooms. The Other Location control allows you to scroll up and down through the levels.
  - You may see a "Retrieving data" screen as the bed gets the information from the Hillrom Digital Health Gateway.
2. After you select the room number, the bed will retrieve the room data, then associate the room to the bed. You will be asked to verify the patient identity (if applicable), you have these options:
    - Continue—press this control if you want to verify the patient. See "Verify the Patient Identity" on page 78.
    - Cancel—press this control if you do not want to verify the patient. The Home screen will show.
    - Change Room—press this control to associate a different room to the bed. The bed will retrieve room data, and then the Available Rooms screen will show. See Step 1.

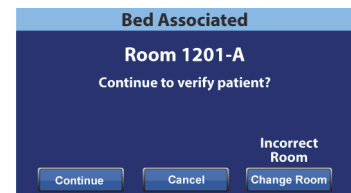

## Confirm the Room to Bed Association

When a room is in the bed’s memory, a room number shows on the Patient Room control, and you are asked where you are located—

- Room number (patient room)—press this control if the room number is correct. The Bed Associated screen will show, and you will be asked to verify the patient. To do so, press **Continue**, then go to “Verify the Patient Identity” on page 78.
- New Room—press this control to associate a different room to the bed. The Available rooms screen will show. See “Associate a Room to the Bed” on page 77.
- Transport—press this control if the bed is not to be associated to a room and the bed is not in a patient’s room. The Home screen will show.



## Override the Room to Bed Association

It is possible that when you try to associate the bed to the room that you are in, another bed has been assigned to the room in error. You can override a conflicting bed to room association as follows:

### NOTE:

You cannot override the association of a bed that is connected to a 37-pin connection.

1. When you plug in the bed after you enter a room and select the last Patient Room on the Bed Location screen, it will show that another bed is associated to the room. If you are sure that this is the room you are in, press **Continue**.
2. If you want to continue with verifying the patient, press **Continue** (see “Verify the Patient Identity” on page 78). Otherwise, press **Cancel** to go to the Home screen.

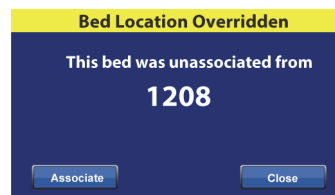
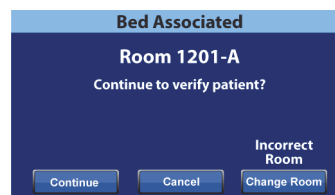
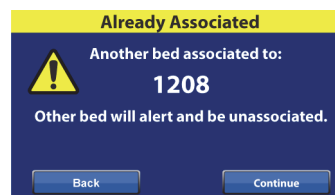

### NOTE:

When a bed association is overridden, the overridden bed will sound a repeating audible tone and the Bed Location Overridden screen will show until you respond. The overridden bed can then be associated to the correct room.

## Verify the Patient Identity

### NOTES:

- The first time that you verify a patient, the full name will show on the screen. After that, the name will be encoded per the Health Insurance Portability and Accountability Act (HIPAA).
- The date of birth is shown as month (two-digit), day (two-digit), and year (four-digit).

At the Patient Identity screen, you have these options:

- Yes—press this control if the patient identity shown is correct. The Home screen will show with the Room Associated and Patient Verified icons.
- No—press this control if the patient identity shown on the screen is not correct. The Patient ID Issue screen will show to let you know that a different patient is assigned to the room through the Admit, Discharge, Transfer (ADT) system. Press OK. The Home screen will show with the Room Associated and No Patient icons.
- Cancel—press this control if you no longer want to verify the patient identity. The Home screen will show with the Room Associated and No Patient icons.

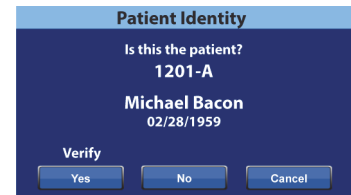

#### NOTES:

- If a different patient has been assigned to the room through the ADT system, this Patient ID Issue screen will show. Press OK. The Home screen will show with the Room Associated and No Patient icons.
- If the patient has not been assigned to the selected room through the ADT system, this Patient ID Issue screen will show. Press OK. The Home screen will show with the Room Associated and No Patient icons.

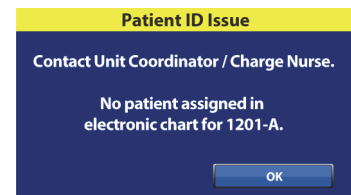
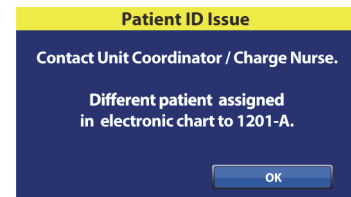

## Verify the Patient Identity when Zeroing the Scale

When Bedside Association is On, and you zero the scale for a new patient, you will be asked to verify the bed location and, if applicable, patient identity.

- If you are verifying the bed location and patient identity, the Patient Identity screen will show. You have these options:
  - Yes—press this control if the patient identity shown is correct. The zeroing process will continue.
  - No—press this control if the patient identity shown is not correct. You will be directed to contact the unit coordinator / charge nurse. From that screen, you can continue with the zeroing process.
  - Cancel—press this control if you do not want to verify the patient identity. The zeroing process will continue.
- If you are verifying the bed location only, the Bed Location screen will show. You have these options:
  - Room number (patient room)—press this control if the room number is correct. The zeroing process will continue.

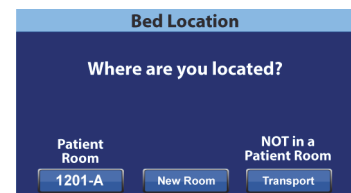

- New Room—press this control to associate a different room to the bed. The Available rooms screen will show. See “Associate a Room to the Bed” on page 77. After you make the room selection, the zeroing process will continue.
- Transport—press this control if the bed is not to be associated to a room and the bed is not in a patient room. The zeroing process will continue.

At the end of the zeroing process, you will see one of these screens as applicable:

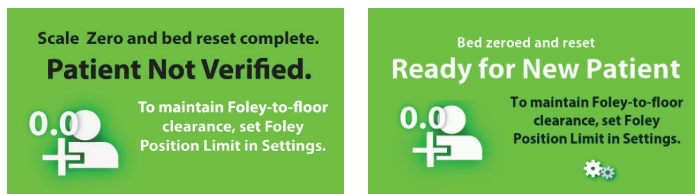

### New Patient Assignment and Bedside Association

When a new patient is assigned to the bed through the ADT system, this screen will show and stay on the screen until the question is answered. Also, a repeating tone will sound. You have these options:

- Continue—press this control if the room number shown on the screen is correct and you want to verify the patient. See “Verify the Patient Identity” on page 78.
- Cancel—press this control if you do not want to verify the patient. The Home screen will show.
- Change Room—press this control to associate a different room to the bed. The bed will retrieve room data, and then the Available Rooms screen will show. See “Associate a Room to the Bed” on page 77.

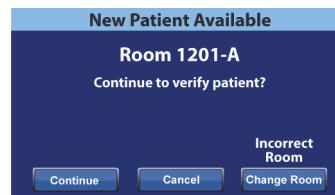

### Weighing and Bedside Association

When Bedside Association is On and you press the Weigh control, the screen that shows may differ depending on whether the patient identity has been verified:

- **Patient Identity Verified**—you will be asked to re-verify the patient identity so that the weight data can be sent to the electronic medical records (EMR). You have these options:
  - Yes—press this control if the patient identity shown is correct. The weighing process will continue. At the end of the weighing process, a confirmation screen will show “Current weight sent to EMR.”
  - No—press this control if the patient identity shown is not correct. A Patient ID Issue screen will show. From that screen you can choose to save the weight to the bed (the weighing process will continue) or cancel the weighing (the Home screen will show).
  - Cancel—press this control if you do not want to verify the patient identity. The Weigh/Zero screen will show; a weight will not be taken.

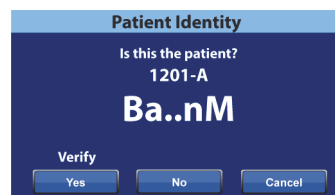

- **Patient Identity not Verified**—you will be asked where to save the weight. You have these options:
  - Bed—press this control if you want the weight saved to the bed only. The weighing process will continue. At the end of the weighing process, a confirmation screen will show “Current weight saved to bed.”
  - Bed & EMR—press this control to save the weight to the bed and EMR. You will be asked to verify the bed association and, if applicable, patient identity.
    - If a room is associated to the bed, you will be asked to verify the patient identity. See “Verify the Patient Identity” on page 78.
    - If a room is not associated to the bed, a location selection screen will show. See “Associate a Room to the Bed” on page 77.

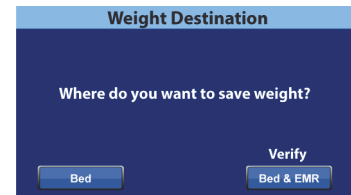

When the bed location and patient identity have been verified, the weighing process will continue unless the weighing is canceled. At the end of the weighing process, if the patient identity has been verified, a confirmation screen will show “Current weight sent to EMR.”

## HR/RR Monitoring and Bedside Association

When you turn on the HR/RR Monitoring while Bedside Association is On, you will be asked to verify the bed location and, if applicable, patient identity.

- If you are verifying the bed location and patient identity, the Patient Identity screen will show. You have these options:
  - Yes—press this control if the patient identity shown is correct. The Room Associated and Patient Verified icons and HR/RR will show on the Home screen.
  - No—press this control if the patient identity shown on the screen is not correct. You will be directed to contact the unit coordinator / charge nurse. Press Okay to go to the Home screen. The Room Associated and No Patient icons and HR/RR will show.
  - Cancel—press this control if you do not want to verify the patient identity. HR/RR will remain Off.
- If you are verifying the bed location only, the Bed Location screen will show. You have these options:
  - Room Number (patient room)—press this control if the room number is correct. The Room Associated icon and HR/RR will show on the Home screen.
  - New Room—press this control to associate a different room to the bed. The Available rooms screen will show. See “Associate a Room to the Bed” on page 5. After you make the room selection, the Room Associated icon and HR/RR will show on the Home screen.
  - Transport—press this control if you do not want to verify the bed location. HR/RR will remain Off.

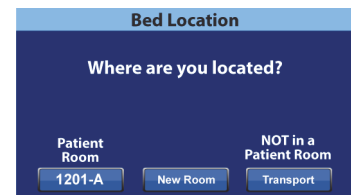
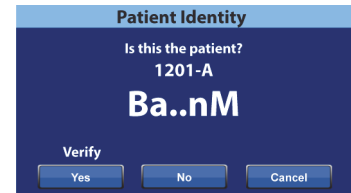

### NOTE:

If a room is not in the bed’s memory, a room location selection screen will show. See “Associate a Room to the Bed” on page 77.

### Bedside Association Notes:

- When the bed is correctly associated to a room and the patient identity is verified, the Home screen will show the Room Associated and Patient Verified icons.

If the Bed Exit monitoring is On, the Room Associated and Patient Verified icons will show on the status screens also:

- Status screen with the HR/RR Monitoring On.



- Status screen with the HR/RR Monitoring Off.

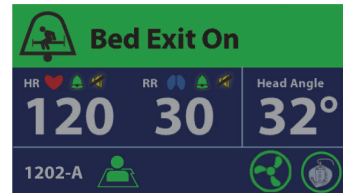

- If there is an issue with the network server while you are trying to associate the bed to a room, this screen will show. A location will not be associated, press Close to go to the Home screen.

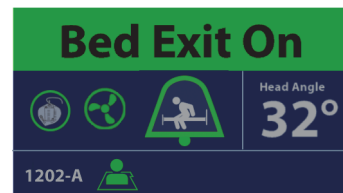

- If Bedside Association is On and the connection to the Hillrom Digital Health Gateway is lost, this screen will show. Press OK to go to the Home screen.

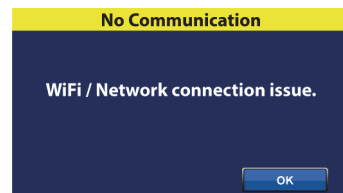
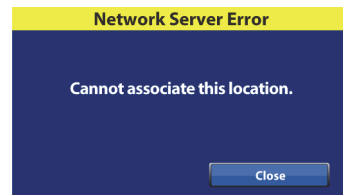



---

## HEART AND RESPIRATION RATE MONITORING SYSTEM

### INTENDED USE

The **Hill-Rom** Heart and Respiration Rate Monitoring System is used with compatible bed system models and is intended for continuous measurement of respiration rate (RR) and heart rate (HR) in an automatic, contact-less manner. The system is indicated for use in children, adolescents, and adults in hospitals or clinical settings. It is intended to be used for the same patient populations and the same settings, within these ranges, as the bed with which it is used. The system has been validated to withstand up to 700 lb (318 kg).

### NOTE:

Do not exceed the limit of the bed system for weight, population, or use setting.

### SYMBOLS

#### Document Symbols













This manual contains different typefaces and symbols to make the content easier to read and understand:

- Standard text—used for regular data.
- **Boldface text**—emphasizes a word or phrase.
- **NOTE:**—sets apart special data or important instruction clarification.
- CONTRAINDICATION, WARNING, or CAUTION





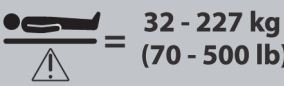











- A CONTRAINDICATION identifies situations or actions that may have an effect on patient safety.
- A WARNING identifies situations or actions that may have an effect on patient or user safety. To ignore a warning could cause patient or user injury.
- A CAUTION identifies special procedures or precautions that persons must obey to help prevent equipment damage.

## Product Symbols

Symbol	Description	Symbol	Description
	Ground plug—only use grounded plug outlets  Transport warning (page 116)		Electrical shock warning: unplug all power cords before service
	WARNING (yellow and black)	<b>IPX4</b>	HR/RR monitoring sensor—According to IEC 60529, rating for protection against fluid ingress and identified as equipment that is protected against spraying and splashing water
	CAUTION (white and black)		Type B applied part according to IEC 60601-1
	ATTENTION: Consult accompanying documents		MEDICAL—GENERAL MEDICAL EQUIPMENT AS TO ELECTRICAL SHOCK, FIRE AND MECHANICAL HAZARDS ONLY IN ACCORDANCE WITH AAMI ES60601-1, IEC 60601-1, IEC 60601-2-52, CAN/CSA C22.2 NO 60601-1 AND IEC 60601-2-49
	Manufacturer		Must consult accompanying documents
	Manufacture date		Patient minimum and maximum weight range (page 1)
	Do not use with Oxygen Tents		Unsafe for use with MRI equipment

## GCI Symbols—HR/RR Monitoring System

Symbol	Description	Page	Symbol	Description	Page
	Heart Rate—ON	95		Out of Room Alarm—ON indicator	101
	Respiration Rate—ON	95		Out of Room Alarm—OFF indicator	101
	Heart Rate—OFF	100		In-room Alarm—OFF indicator	100
	Respiration Rate—OFF	100		In-room Alarm—ON indicator	100
	Unstable signal	96		Lost patient signal	96
	Service required	96		Multiple Alarms (HR, RR, Service, or HR/RR monitoring sensor)	96
	Resume Monitoring	98		Suspended Alarm	98

## HR/RR MONITORING SYSTEM SPECIFICATION

	Heart Rate	Respiration Rate
Range	30 - 170 beats per minute (BPM)	6 - 45 breaths per minute (Br/min)
Average Period	1 minute	1 minute
Accuracy	+/- 4% or +/- 5 BPM whichever is greater	+/- 4% or +/- 1.5 Br/min whichever is greater

## HR AND RR MONITORING SYSTEM INFORMATION

Read all precautionary information and specifications before use.

**CONTRAINDICATION:**

The Heart and Respiration Rate Monitoring System is contraindicated for use in—

- **Contraindication**—Patients whose proper positioning cannot be achieved or maintained.
- **Contraindication**—Patients who do not meet the weight limits tested or specified.
- **Contraindication**—Situations where a dry environment cannot be ensured.
- **Contraindication**—An MRI environment.
- **Contraindication**—An explosive atmosphere or in the presence of flammable anesthetics or gases.



**WARNING:**

To prevent injury or equipment damage obey these warnings:

- **Warning**—Read and understand all **warnings** on the unit itself prior to use with a patient.
- **Warning**—The **Centrella** Smart+ Bed with or without the Heart and Respiration Rate Monitoring System, has an intended patient range of 70 lb (32 kg) to 500 lb (227 kg). Use of the bed with patients outside the intended patient weight range may increase the risk of entrapment, asphyxiation, and/or loss of therapeutic value. Use of the bed with patients above the bed's intended maximum patient weight may also cause damage the bed.
- **Warning**—Follow the product manufacturer's instructions.
- **Warning**—The potential for electrical shock exists with electric equipment. Failure to follow facility protocols may cause death or serious injury.
- **Warning**—To avoid risk of electric shock, this equipment must only be connected to a supply mains with protective earth.
- **Warning**—Make sure to use a correctly grounded, three-prong, 120 V outlet (NEMA 5-15R or NEMA 5-200R outlet, rated 125 V AC, 15 A or 125 V AC, 20 A, respectively). Failure to do so could cause personal injury, fire, or damage to the equipment or facility wiring.
- **Warning**—Connect the power cord to hospital grade receptacles only.
- **Warning**—Incorrect use or handling of the power cord may cause damage to the power cord.
- **Warning**—Take care to minimize the risk of tripping over the power cord by carefully locating it from the unit to its power source.
- **Warning**—Make sure the position of the unit is such that you can quickly, without obstruction, unplug the power cord from the main power supply if necessary.
- **Warning**—Do not use the bed in an oxygen rich environment or with oxygen tents.
- **Warning**—Do not operate the bed in the presence of flammable gas or vapors.
- **Warning**—Do not operate the bed in the presence of flammable anesthetics or nitrous oxide.
- **Warning**—Before maintenance or service is done on the unit, make sure to unplug the unit and remove the patient or fully remove the unit from use.
- **Warning**—Operate the bed within the stated environmental conditions; see "Environmental Conditions for Use" on page 140.
- **Warning**—This device is not compatible for use in Magnetic Resonance Imaging (MRI).
- **Warning**—Do not connect the power cord to an extension cord or multiple outlet strip. There is a risk of overheating and fire may cause injury or damage.
- **Warning**—Connect only items that have been specified as parts of the device or compatible with the device.
- **Warning**—Consult your local regulations to safely discard or recycle electronic equipment and batteries.
- **Warning**—Do not discard as unsorted municipal waste. See your local distributor for collection and/or recycling system available in your country.
- **Warning**—Federal USA law restricts this device to sale by or on the order of a physician.
- **Warning**—The data acquired by HR and RR Monitoring System should be interpreted by a Healthcare Practitioner only.

**WARNING:**

(Warnings continued) To prevent injury and/or equipment damage obey these warnings:

- **Warning**—The HR and RR Monitoring System is not intended for monitoring high risk situations where ECG monitoring is required. The most reliable method of patient monitoring combines close personal surveillance with correct operation of the monitoring equipment.
- **Warning**—Changes or modifications not expressly approved by Hill-Rom could affect the safety or effectiveness of the HR/RR Monitoring sensor and void the system warranty.
- **Warning**—Do not use a damaged HR/RR Monitoring sensor. Use of damaged components might result in malfunctioning of the system.
- **Warning**—Only facility-authorized maintenance persons should install the HR/RR Monitoring sensor.
- **Warning**—Only Hill-Rom qualified persons should service the HR/RR Monitoring sensor.
- **Warning**—The HR/RR Monitoring sensor contains no serviceable parts. Do not open the system covers.
- **Warning**—Do not share the bed with another person or pet when the HR/RR Monitoring sensor is active. Sharing the bed could affect the effectiveness of the system and the accuracy of the measurements.
- **Warning**—Alarm threshold settings are patient or facility specific. The clinician must set and verify alarm thresholds appropriate for each patient. Each time the bed is powered on, you must check that the alarm settings are appropriate for your patient before you start monitoring. Failure to set alarms appropriately can lead to false alarms or failure to alarm. Alarming will only operate properly if set up properly.
- **Warning**—Avoid using heating blankets. Use of heating blankets could affect the safety or effectiveness of the HR/RR Monitoring sensor and void the system's warranty.
- **Warning**—Do not use the HR/RR Monitoring sensor for patients who weigh more than the limit of the HR and RR Monitoring System, which is 700 lb (318 kg), or the associated Bed System, which for the **Centrella** Smart+ Bed is 500 lb (277 kg), whichever is lower.
- **Warning**—The use of the HR/RR Monitoring sensor on the bed, close to any adjacent source of vibration, might influence the accuracy of the system's measurements or create periodic interferences with the measurement.
- **Warning**—All wireless systems are prone to intermittent signal dropout. Make sure the patient only has conditions which can tolerate intermittent monitoring interruptions.

**CAUTION:**

To help prevent equipment damage, obey these cautions:

- **Caution**—The system is intended for indoor operation only.
- **Caution**—The patient should not have direct contact with the HR/RR Monitoring sensor. A mattress should always be placed as a barrier between the HR/RR Monitoring sensor and the patient. The patient should be frequently checked to make sure direct contact does not occur.
- **Caution**—Use only parts and accessories from Hill-Rom. Do not modify or change the bed system without approval from Hill-Rom.

## NOTES:

- The HR/RR Monitoring sensor must be replaced after five years of continuous use to make sure the system operates correctly. A notification will show on the GCI when it is time to replace the sensor.
- The HR and RR Monitoring System has not been studied on any specific patient group, nor has it been studied as a diagnostic tool for any specific disease or medical condition. It is meant as an adjunctive tool only for measuring respiration and heart rate.
- The HR/RR Monitoring sensor is rated for continuous operation.
- It has been determined that the HR and RR Monitoring System has no performance, the loss of that would result in unacceptable risk.
- The HR/RR Monitoring sensor is rated IPX4, splash proof.
- If the number is gray, the sensor cannot read the HR or RR to measure. The last measured result will show on the screen in gray.
- When the patient is out of the bed "--" will show for the measurement.
- The system can detect a heart rate that is greater than 1.8 times of the respiration rate.
- The total system accuracy including undetected signals is 90% for respiration rate and for heart rate.
- A Bed Exit Alert will have priority over a heart rate or respiration rate alarm. You must address the Bed Exit Alert before the heart rate or respiration rate alarm will show on the touchscreen.
- The HR and RR Monitoring System can interface with existing nurse call system found in the facility, though the actual connection to the nurse call system requires the support of your facility-authorized maintenance persons.
- Heart and respiration rate values are most likely to show when the patient is centered (left to right) and the angle of the bed's head section is as low as clinically appropriate.
- There must be AC power to the bed for the HR/RR Monitoring System to operate.
- For Preventive Maintenance for the HR/RR Monitoring System, see "Preventive Maintenance" on page 135.
- For Environmental Conditions for Use for the HR/RR Monitoring System, see "Environmental Conditions for Use" on page 140.



## INTRODUCTION

The HR and RR Monitoring System is designed to provide a Contact-Free Continuous Monitoring Solution (CFCM) of heart and respiration rate with the use of the HR/RR Monitoring sensor. The touchscreen shows numerical heart and respiration rates as well as graphical data of trends of these parameters. The system sounds an alarm to notify the caregiver when the HR or RR averaged over time, passes above or below the user defined limits or thresholds.

The sensor is placed between the mattress and the bed at the head end. The data provided by the system is intended to aid in the evaluation process of a patient's clinical status and should be interpreted by a Healthcare Practitioner only.

The system begins to monitor the patient's HR and RR within two to four minutes after the patient is quietly lying still. The measured data is continuously saved and can be viewed on the touchscreen. To look at the HR and RR data over time, see "HR and RR Trends Screen" on page 96. The heart and respiration rate are shown in several screen views, see below.



Home Screen



Status Screen

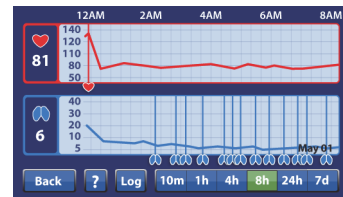

Trends Screen

**NOTE:**

If you do not want the heart and respiration rate to show on the screen, see "Turn ON/OFF HR and RR Display" on page 95.

**ALARM, ALERTS, AND INFORMATION INDICATORS**

The Information Indicators provide the caregiver with audible indicators and visual indicators.

**NOTE:**

There must be either AC or battery power to the bed for the indicators to operate.

**Low Priority Alarm**

If the HR and RR option is active, a two-tone alarm will sound every 3 seconds to indicate that a HR or RR alarm is active, and a priority nurse call is sent to the nurse's station (for beds equipped and connected to a Nurse Call System).

Low Priority Alarm Parameters (HR/RR Monitoring System)

	Low Heart Rate	High Heart Rate
Time to alarm for change in HR	90 seconds	90 seconds
	Low Respiration Rate	High Respiration Rate
Time to alarm for change in RR	180 seconds	180 seconds

**Beep Alerts**

A single beep will sound when an activity is successful.

A triple beep will sound to indicate that you should look at the touchscreen, attention is needed.

For a critical fault, a triple beep will sound every 10 seconds until the user acknowledges the error on the touchscreen. Follow the on-screen instructions. If the critical fault is not resolved, the triple beep will sound again after an hour. The cycle will continue until the issue is resolved.

A low volume repeating triple beep every 10 seconds will sound to remind you that the **Bed Exit** is silenced and should be resumed before you leave the room.

A quadruple beep (four beeps) will sound to indicate a Bed Exit alert.

A continuous tone will sound to indicate a serious bed malfunction and that immediate attention is needed.

## ACTIVATE THE TRIAL MODE

Hill-Rom offers a free 90-day trial of the HR and RR Monitoring System. When the 90-day trial has passed, the system will turn off or you can contact Hill-Rom for a licensed activation code to continue to use the system.

To activate the 90-day trial do these steps:

1. Look at the bed revision. If the bed is revision A, the bed needs upgraded with the Heart and Respiration Rate (HR/RR) Monitoring System. Contact Hill-Rom.

If your bed is revision B, the operating system must be software version **1.29** of higher (see "Settings/Preferences" on page 68). If it is not, contact Hill-Rom.

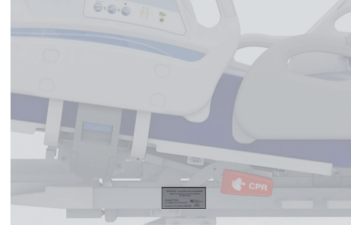

### NOTE:

The bed must be empty to activate the heart and respiration rate monitoring.

2. Lower the siderails.
3. Disconnect the mattress attachments knobs from the bed frame at the head end of the bed.
4. Lift the head end of the mattress and remove the protective tab from the sensor.
5. Reconnect the mattress attachments knob to the bed frame.
6. Press the **HR/RR** menu control.



7. Contact your local Hill-Rom representative to receive the activation code. Make sure to specify that the code is for the trial mode.



8. Press **Activate 90-day Trial Mode**.

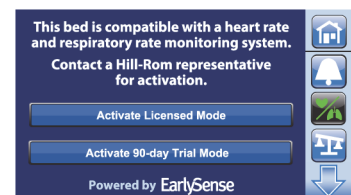

9. Enter the activation code and press **Enter**.

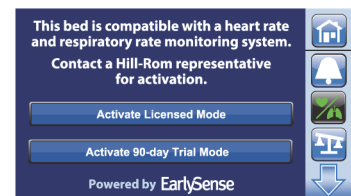



10. Follow the on-screen instructions, and press **Exit** when complete.

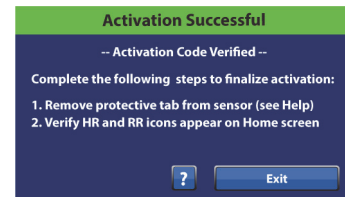

11. Press the **Home** menu control. The HR and RR symbols will show in the bed indicators section of the Home screen.

**NOTES:**

- The HR/RR values will show by default when a patient is in the bed. To turn off the HR/RR display, see "Turn ON/OFF HR and RR Display" on page 95.
- After approximately five minutes, the touchscreen will default to the Status screen.



12. Reset the bed as follows:

- Unplug the bed.
- Press and hold the Lockout control (A) until you hear a beep (approximately 20 seconds). This puts the bed in Service mode.
- Press and hold these controls at the same time until you hear a beep: Foot Up (B), Foot Down (C), and Trendelenburg (D). The bed should shut down within 5 seconds after you release the controls.
- Plug the bed in.

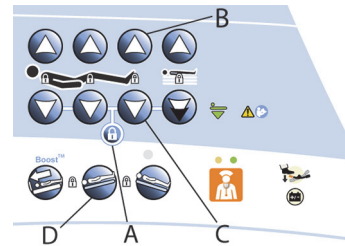
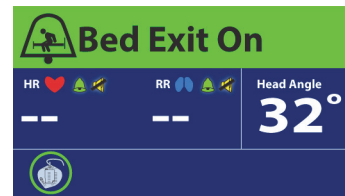

**NOTE:**

The HR and RR Monitoring System uses the same speaker as the Brake Not Set Alert for in-room alerts.

13. To check the HR and RR Monitoring System in-room alarm, do as follows:

- Put the brake or steer pedal in the level position.
- Make sure the alarm sounds.

**NOTES:**

- To see the number of trial days that remain, press the HR/RR menu control. The number of days will show for 3 seconds.
- The watermark "TRIAL" will show on the HR/RR screen when the trial mode is active.
- Once the trial mode is activated, the trial mode control will be gray and not operate.

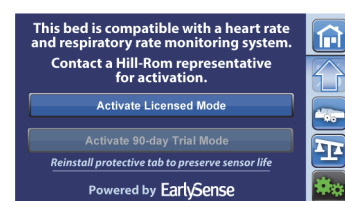
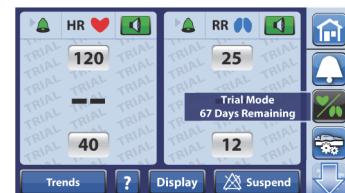

## ACTIVATE THE LICENSED MODE

HR and RR Monitoring must be activated prior to use. Contact Hill-Rom to activate this feature. When you contact Hill-Rom, be prepared to give the bed's serial number. The serial number is on the right side of the upper frame at the head end of the bed.

### NOTE:

The bed must be empty to activate the heart and respiration rate monitoring.

1. Press the **HR/RR** menu control.



2. Contact Hill-Rom to receive the activation license code. Make sure to specify that the code is for the licensed mode.

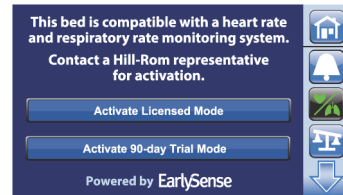

### NOTE:

If the Activation control is not included on the screen, the software to monitor HR and RR is not installed. Contact Hill-Rom.

3. Press **Activate Licensed Mode**.



4. Enter the activation code, and press **Enter**.



5. Follow the on-screen instructions, and press **Exit** when complete.

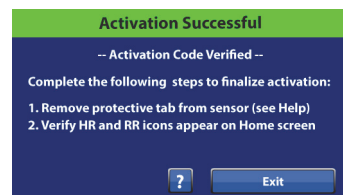

6. Press the **Home** menu control. The HR and RR symbols will show in the bed indicators section of the Home screen.

### NOTES:

- The HR/RR values will show by default when a patient is in the bed.



- After approximately five minutes, the touchscreen will default to the Status screen.

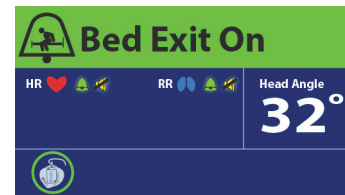

7. Reset the bed as follows:

- Unplug the bed.
- Press and hold the Lockout control (A) until you hear a beep (approximately 20 seconds). This puts the bed in Service mode.
- Press and hold these controls at the same time until you hear a beep: Foot Up (B), Foot Down (C), and Trendelenburg (D). The bed should shut down within 5 seconds after you release the controls.
- Plug the bed in.

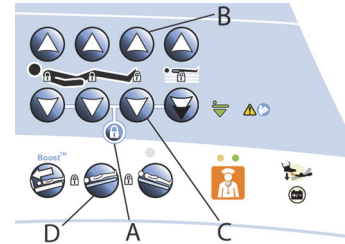

**NOTE:**

The HR and RR Monitoring System uses the same speaker as the Brake Not Set Alert for in-room alerts.

8. To check the HR and RR Monitoring System in-room alarm, do as follows:
- Move the brake or steer pedal to the level position.
  - Listen for an alarm to sound.

**RESET HR AND RR DATA**

To reset the HR and RR data, do the New Patient (Zero) scale procedure as follows:



**WARNING:**

These warnings apply to both zero the scale and weigh procedures. To help prevent injury and/or equipment damage, obey these **warnings**:

- **Warning**—The scale is very sensitive. Make sure the bed is not touching anything that could affect the patient weight (other beds or carts, headwall, miscellaneous drainage lines, etc.) while the bed is in the **zeroing or weighing** process. Failure to do so could cause an inaccurate weight reading.
- **Warning**—Always use the **New Patient** zero before a patient is admitted into the bed. Failure to do so may keep old patient data in the bed and cause a risk to the new patient.

**NOTES:**

These notes apply to both zero the scale and weigh procedures:

- The scale will only work when the bed is connected to AC power.
- The equipment in the foot-end sockets **will** be included in the Zero and patient Weigh processes.
- Everything on or attached to the articulating upper frame and siderails **will** be included in the Zero and patient Weigh processes.

Use New Patient zero every time a new patient is admitted to the bed.

The New Patient control will—

- Clear the previous and current weight history
- Zero the scale
- Reset these features:
  - Bed Exit Alert to off
  - **SafeView+** Alerts option to the default protocol
  - HR and RR monitoring data
  - Audible indicator to the default protocol
  - Alert setting to the default protocol
  - Head <30° Limit to off
  - Frame lockouts to off
  - Comfort settings to Normal

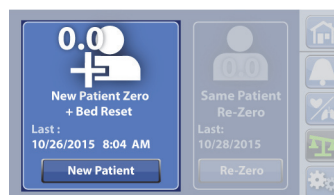

1. Press **New Patient**.

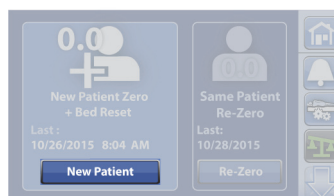

2. A reminder message shows. Follow the on-screen instructions.

**NOTES:**

- Remove everything attached to the upper frame, siderails, and foot end of the bed or the items **will** be included in the patient's weight.
- The headboard and devices mounted to the head end of the bed **will not** be included in the patient's weight.
- **Cancel** will return the touchscreen to the previous screen.



3. The touchscreen will show that the bed is zeroing. Do not touch the bed while the bed zeroes.

**NOTES:**

- If the "Not In Required Position" screen shows, press the Adjust Bed Button on the touchscreen.
- If the "Difference from Last Zero" caution screen shows, re-check the bed for items that should be included during the zero.
- The scale will not zero if there is more than a 45 kg (99.2 lb) weight difference from the last zero. This is to reduce the possibility of zeroing the scale with a patient in the bed.

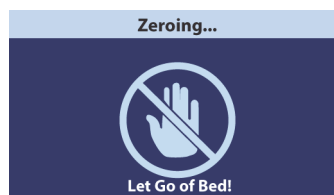

4. A single beep will sound, and the touchscreen will show that the bed is ready for a new patient. To return to the **Home** screen, touch the screen or place a patient in the bed.



**TURN ON/OFF HR AND RR DISPLAY**

1. Press the **HR/RR** menu control.
2. Press **Display**.
3. Press **Yes** or **No**, and then **Accept**.

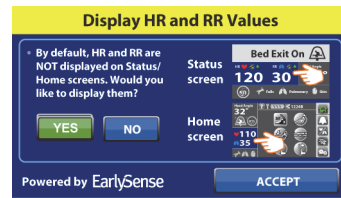
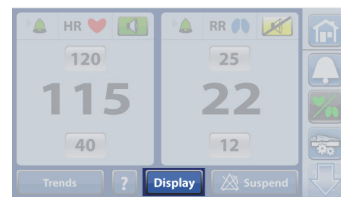

## HR AND RR TRENDS SCREEN

HR and RR trends screen shows measurements over time.

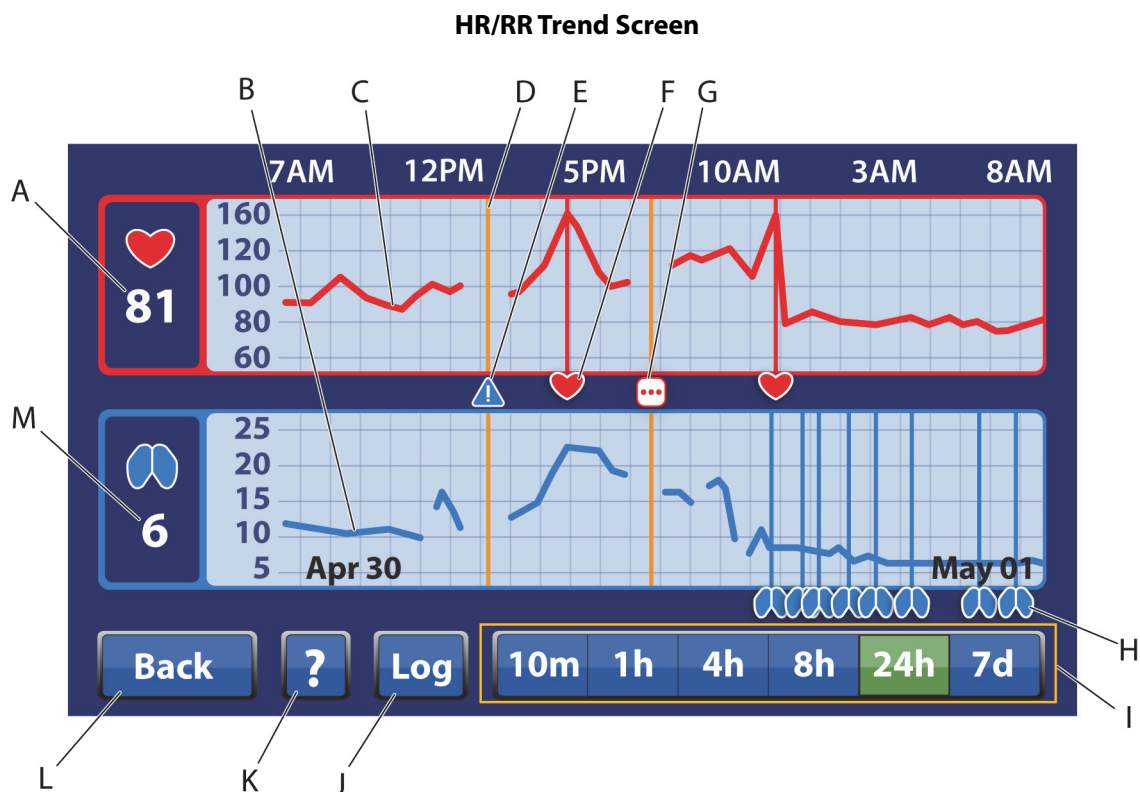

Item	Description	Item	Description
A	Current heart rate in beats per minute (BPM)	H	Respiration Rate Alarm
B	Respiration rate trend	I	Time period view options (10 minutes, 1 hour, 4 hours, 8 hours, 24 hours, 7 days)
C	Heart rate trend	J	Log—shows a list of Logged Alarms
D	Service Alert	K	Help (?) Control
E	Service Required	L	Back—takes you to the previous screen
F	Heart Rate Alarm	M	Current respiration rate in breaths per minute (Br/min)
G	Multiple Alarms		

### To View HR and RR Trends

1. Press the **HR/RR** menu control.

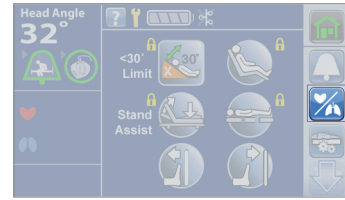

2. Press **Trends**.

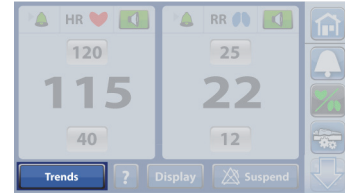

3. Press **Accept**.

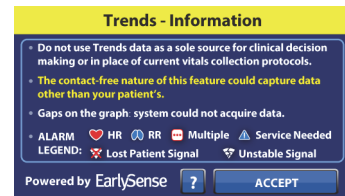

4. Select the time period view.

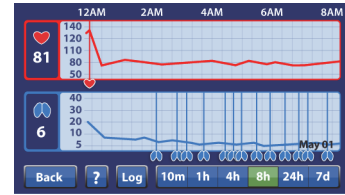

#### NOTES

- The Trends screen default is 8 hours.
- If the sensor expired, you can view the previous trend data through the Trends control.

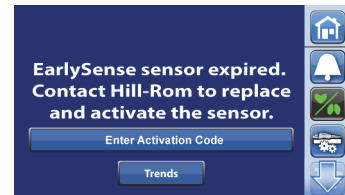

### CHANGE HR AND RR ALARM THRESHOLDS

#### HR and RR Alarm Thresholds Specification

	Heart Rate	Respiration Rate
Default Alarm Thresholds	Low = 40 BPM	Low = 8 Br./min
	High = 130 BPM	High = 32 Br./min
Min. to Max. Settable Alarm Thresholds	Low: 35 BPM	Low: 8 Br./min
	High: 150 BPM	High: 44 Br./min

1. Press the **HR/RR** menu control.



2. Press the number for the alarm threshold that you want to change.



3. Press the **Up** or **Down** arrows to the desired threshold.

**NOTES:**

- The Up and Down arrows will no longer show after 4 seconds if an arrow is not pressed.
- A red box will show around the number if the number is changed from the default threshold.



4. To change the default thresholds, contact your facility-authorized maintenance persons or Hill-Rom Technical Support for assistance.

**NOTE:**

The HR and RR Monitoring System returns to the default threshold settings when the New Patient (Zero) scale procedure is performed. See “Reset HR and RR Data” on page 93.

## Alarms

The alarms are used to notify caregivers of situations that may require attention. Visual and audible (if enabled) alarms occur when the HR or RR, averaged over time, passes above or below the user defined threshold. A low priority alarm will sound for HR and/or RR alarms, and a triple beep alert will sound for HR and RR technical alarms. For a description of alerts and alarms, see “Alarm, Alerts, and Information Indicators” on page 89.

If the system has a HR and/or RR alarm, these will occur:

- An audible alarm will sound if enabled.
- A yellow corresponding alarm parameter on the touchscreen will show. A message will show on the bottom of the touchscreen to describe the alarm, and the time since the alarm was activated. The alarm screen is noticeable from 4 meters (13 feet) and can be read from the caregiver bedside position.
- If the bed is equipped and connected to a Nurse Call System, a priority nurse call is sent to the nurse’s station.
- If the bed is equipped with the **SafeView+** Alerts option, an amber flashing indicator will show at the foot end of the bed.

A **Bed Exit Alert will have priority** over a HR or RR alarm. You must address the Bed Exit Alert before the HR or RR alarm will show on the touchscreen.



The HR or RR alarm can be silenced or suspended. The Silence or Suspend control allows the caregiver to temporarily stop alarms from being sent to the bed and/or nurse call system, if connected.

When the Suspend control is pressed, these will occur:

- The yellow alarm message will show and suspends the alarms for 15 minutes.
- A timer will show at the bottom of the touchscreen that will countdown from the time of the alarm.

After 15 minutes, Suspend mode will stop, and the system will resume monitoring the HR and RR.

**High or Low RR Alarm**—a message shows when the respiration rate is above or below the high or low alarm threshold settings.

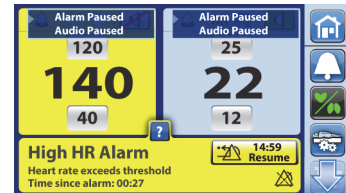
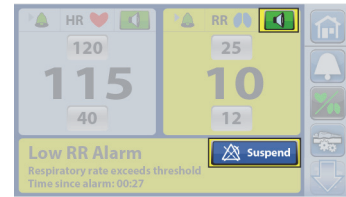

**High or Low HR Alarm**—a message shows when the heart rate is above or below the high or low alarm threshold settings.

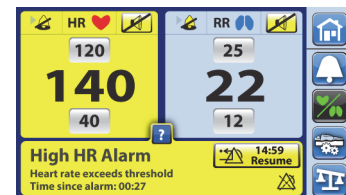
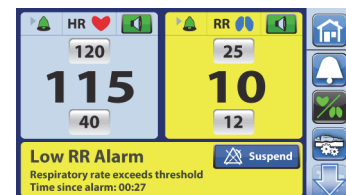

**Lost Patient Signal**—this message shows when the sensor cannot detect the patient signals. Check the patient and sensor location.

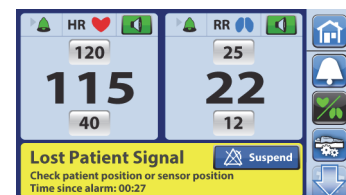

**Unstable Signal**—this message shows when the sensor cannot continually detect the patient. Consider using an alternative monitoring device.

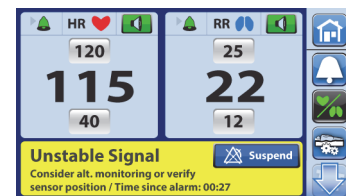

**Bed Sensor Error**—this message shows when the sensor malfunctioned, or the sensor is disconnected. Make sure the sensor cable is fully connected to its port on the back of the head deck panel.

If you replaced the sensor, make sure the activation code was entered correctly.

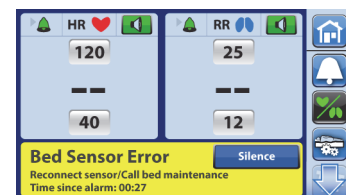

**Sensor Expires Soon**—the sensor will expire in 30 days. Contact Hill-Rom for a replacement sensor. (This is a message screen with no audible notification.)

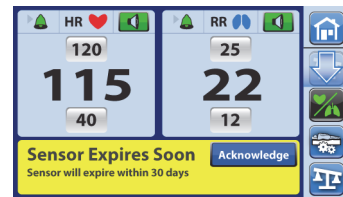

**Sensor Expires Soon**—the sensor will expire in 7 days. Contact Hill-Rom for a replacement sensor. (This is a message screen with no audible notification.)



**Sensor Expired**—HR and RR will not be measured by an expired sensor. Contact Hill-Rom to replace the sensor.

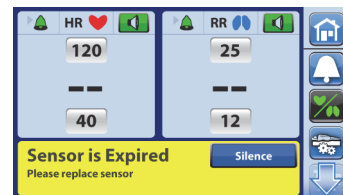

### Turn On/Off In-Room Alarms

The HR and RR Monitoring System has in-room audible and visual alarms. The audio alarms can be disabled if a Nurse Call system is connected. If the system is connected to a Nurse Call System, HR/RR alarm calls will stay active and show as a bed exit alert on the nurse call system. Alarm settings are patient or facility specific. Follow facility protocol regarding when audible alarms should be on or off.

1. Press the **HR/RR** menu control.



2. Press the **HR/RR Alarm Sound** control to turn off in-room audible alarms.

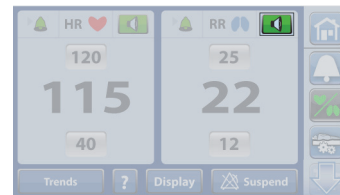

3. Press **Yes**.

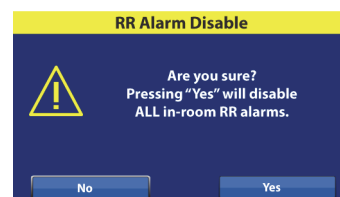

### NOTE:

In-room audible alarms can **only** be disabled when connected to a nurse call system.

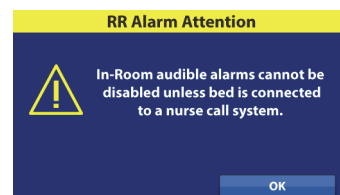

- Make sure the screen shows a message that the alarm is on, and audio is off.
- Make sure the HR/RR Alarm Sound control shows that it is silenced.
- Press the **HR/RR Alarm Sound** control again to enable the audible alarm.

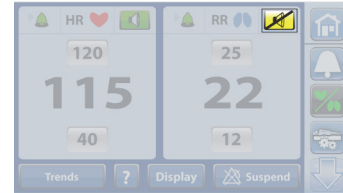
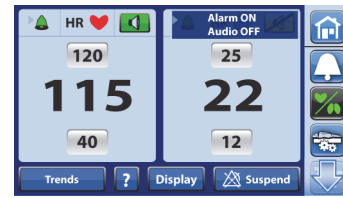

## Turn On/Off Remote Alarms

The HR and RR Monitoring System can provide remote alarms when connected to a Nurse Call System. To turn off the remote RR/HR Alarms, contact your facility-authorized maintenance persons or Hill-Rom Technical Support for assistance.

## Change HR and RR Alarm Volume

The volume can be adjusted for the HR and RR Alarms.

- Press the **Settings/Preferences** menu control.
- Press **HR/RR Monitoring**.
- Press **Volume**.
- Select the volume setting, then press **Accept**.

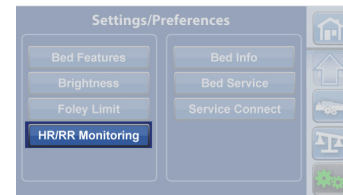

### NOTE:

Contact your facility-authorized maintenance person or Hill-Rom Technical Support for assistance to change the tone of the alarms.

## View HR/RR Alarm Log

The HR/RR Alarm Log provides a list of alarms, the time when the alarm occurred, and the type of alarm. The log will show the last 7 days of alarms. Alarms older than 7 days cannot be viewed.

1. Press the **HR/RR** menu control.



2. Press **Trends**.

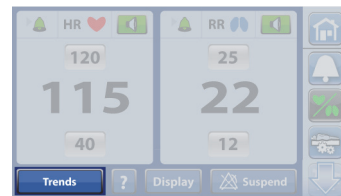

3. Press **Log**.



### NOTE:

The last alarm shows at the top of the screen on the first page.

4. Press the **Up** or **Down** arrow to view additional events logged or press **Back** to go to the previous screen.

HR/RR Alarm Log	
Time	Alarm
01May2017, 7:49AM	Low RR
01May 2017, 7:06AM	Low RR
01May2017, 6:55AM	Low RR
01May2017, 6:28AM	Low RR
01May2017, 5:57AM	Low RR

At the bottom of the table is a 'Back' button.

### NOTES:

- The HR/RR Alarm Log is saved to the bed's memory and is retained when the bed power is lost.
- To clear the patient's HR and RR information, do the New Patient (Zero) scale procedure. See "Reset HR and RR Data" on page 93.

## TURN ON/OFF HR AND RR MONITORING

1. Press the **Settings/Preferences** menu control.



2. Press **HR/RR Monitoring**.



3. Press **System ON/OFF**.

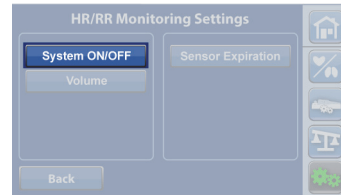

4. Press **Off** or **On**, and then press **Accept**.



5. Press **Yes** or **No**.

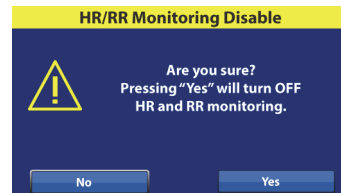

## VIEW SENSOR EXPIRATION INFORMATION

1. Press the **Settings/Preferences** menu control.



2. Press **HR/RR Monitoring**.

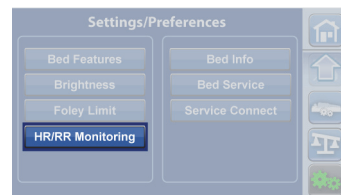

3. Press **Sensor Expiration**.

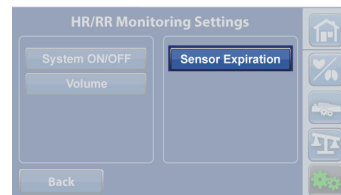

4. Press **Exit** to return to the previous screen.

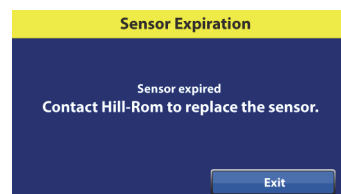

## HR/RR MONITOR ACTIVATED LABEL OPTION

Contact Hill-Rom for the HR/RR Monitor Activated label.

For label placement, see “Department Identification Label Placement” on page 151.



## VOALTE NURSE CALL SYSTEM—HR/RR MONITORING

The **Voalte** Nurse Call System is an enterprise system that connects and monitors certain **Hillrom** products including the HR/RR Monitoring System. When there is an HR/RR alarm, the **Voalte** Nurse Call System sends the alarm status to the network applications for caregivers to view and receive. For complete operational instructions for the **Voalte** Nurse Call System, refer to the **Voalte** Nurse Call System User Manual.

## HILLROM DIGITAL HEALTH GATEWAY—HR/RR MONITORING

The HR/RR Monitoring System can provide data remotely in conjunction with the **Hillrom** Digital Health Gateway. You must have the **Hillrom** Digital Health Gateway version 1.1 or greater for wired or Hillrom Digital Health Gateway version 1.2 or greater for wireless data. The wired data connection is achieved using the **SideCom** Communication System. Wireless data is sent using the Wireless Connectivity Option and is enabled by service personnel per the facility’s request.

---

## MATTRESS INFORMATION



### WARNING:

To help prevent injury and/or equipment damage, obey these **warnings**:

- **Warning**—Some safety features of the bed may not function or may not operate as intended with mattresses that are not designed specifically for this bed. Check with the mattress manufacturer to make sure that the safety features of the bed have been tested and verified to operate correctly with the replacement mattress.
- **Warning**—Only use mattresses of the specified dimension. Contact Customer Service.
- **Warning**—Mattress impermeability and pressure relieving capabilities of the mattress could be affected by needle sticks or other bladder punctures. Caregivers should be instructed to AVOID mattress cover and bladder damage caused by the incorrect use of x-ray cassette holders and sharp objects that may puncture or lacerate the mattress.
- **Warning**—The **Centrella** max mattress is not a substitute for good nursing practices. The **Centrella** max mattress should be used in conjunction with good assessment and protocol. Otherwise, patient injury could occur.
- **Warning**—Do not allow the mattress to come in contact with the headboard, this could impact the scale accuracy and Bed Exit Alert performance.

- **Warning**—Make sure to do these when you install a replacement mattress for use:
  - a. Align the head-end edge of the mattress with the head-end edge of the bed’s head section sleep deck.
  - b. For mattresses with attachment straps, use the slots on the sleep deck to fasten the mattress at the head and foot ends. The patient restraints at the foot end may be used as alternate attachment points. Make sure the mattress attachment does not interfere with the bed articulation.
  - c. Set the length of the bed to the length of the mattress. To do so, use the **FlexAfoot** controls to adjust the foot section until the footboard aligns with the foot-end edge of the mattress. See “FlexAfoot Bed Length Adjustment” on page 49.
  - d. Lock out the **FlexAfoot** controls to avoid any further adjustment to the bed length, see “Lockout” on page 34.

**NOTE:**

Hill-Rom recommends the use of **Hillrom** mattresses that have been designed and tested specifically for the **Centrella** Smart+ Bed. If you purchase a replacement mattress from Hill-Rom or another manufacturer, make sure that the safety features of the bed have been tested and verified to operate correctly with the replacement mattress. The replacement mattress should meet the applicable regulations and technical standards to minimize the risk of injury to the patients and caregivers.

Mattresses should—

- Minimize the gaps where entrapment could occur.
- Allow enough siderail height from the top of the mattress to the top of the siderail to prevent accidental roll-overs.
- Have appropriate firmness to assist with safe patient transfers.
- Not interfere with siderail operation.

For the latest list of mattresses recommended for use, contact Customer Service.

**CONTRAINDICATION:**

**Contraindication**—Use of active therapy surfaces (mattresses) with patients with unstabilized spinal cord injury could cause serious injury to the patient.

Use loose fitted sheets (preferably knitted) for maximum pressure redistribution.

The **Centrella** max mattress is a powered air mattress that has a **MicroClimate Management (MCM)** cover that operates continuously while the patient is on the bed. **MCM** helps decrease localized heat and moisture buildup that occurs between the patient and the mattress.

For the **Centrella** max mattress to operate correctly, there must be a minimum of 70 lb (32 kg) on the mattress.

**Modes**Normal

The normal mode of the mattress provides continuous full-body pressure redistribution for patients 70 to 500 lb (32 to 277 kg). The mattress automatically adjusts the air system to accommodate changes in weight distribution.

Pressure redistribution is always active unless one of these occur:

- Max Inflate is active.
- AC power is not available.
- An error has occurred with the mattress.

The mattress should be regularly examined for damage.

### To Activate

1. Press the **Mattress** menu control.



2. Press **Normal**.



### Max Inflate

The Max Inflate mode maximizes the firmness of the mattress. This assists in patient mattress-to-mattress transfers and/or adjustment of the patient's position.

#### NOTE:

The mattress will automatically exit the Max Inflate mode and return to Normal mode after 15 minutes. When there are 2 minutes left, a beep will sound, and a message will show on the touchscreen. The caregiver will have the option to keep the mattress in Max Inflate mode or let it return to Normal mode.

### To Activate

1. Press the **Mattress** menu control.



2. Press **Max Inflate**.

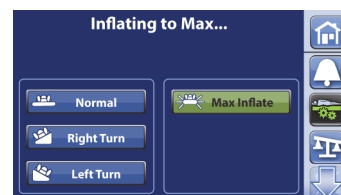

### To Deactivate

Let the mode time out, or press the **Mattress** menu control, and then press Normal.

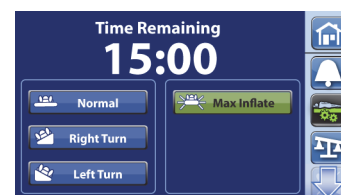



## Patient Comfort

Patient Comfort lets you adjust the pressure settings for the patient's comfort and still provide pressure redistribution. There are two zones to adjust. Adjustments through the touchscreen permit you to adjust the two zones separately. While adjustments through the patient pendant adjusts both zones at the same time. For patient pendant use, see page 39. The system automatically supplies pressure distribution for the patient's position on the mattress.

### To Adjust the Firmness

1. Press the **Mattress** menu control.
2. Press **Comfort**.
3. Use the **Comfort Adjustment** controls to change the pressure in the head and seat sections of the mattress.
  - To **Increase** the pressure, press the **Up** arrow.
  - To **Decrease** the pressure, press the **Down** arrow.



### To Turn On/Off the Patient Comfort Controls on the Patient Pendant (Handheld Remote)

1. Press the **Mattress** menu control.
2. Press **Comfort**.
3. Press **On** or **Off** to allow the use of the comfort controls on the patient pendant.



## pro+ Mattress

1. Press the **MCM** menu control.



2. Press **On**.



3. Press **OK**.



At the Home screen, make sure the green status indicator shows.



### To Troubleshoot Messages

**MCM Off for 12 Hours** (MCM problem)—this message shows when the **MCM** has been turned off for over 12 hours. Press **Remain Off** or **Turn On** for the **MCM** feature.

**Warning**—Failure to correct the error in a timely manner may cause patient injury.

**Error** (technical problem)—this message shows when the **MCM** blower does not operate as intended. Contact your authorized maintenance persons.

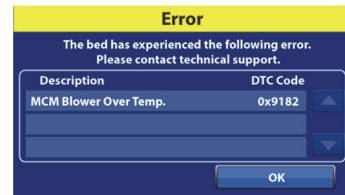

## Turn Assist



### WARNING:

To help prevent injury and or equipment damage, obey these **warnings**:

- **Warning**—Do not use the Turn Assist feature while the patient is restrained.
- **Warning**—Make sure that the lines are not pinched or kinked and that there is sufficient slack in the lines for bed articulations and patient movement.
- **Warning**—Make sure that no hands or arms are under the mattress or between the mattress and siderail during Turn Assist.
- **Warning**—Unplug any personal electronic devices from the USB port and remove any loose items from the mattress before you activate Turn Assist.

Turn Assist helps the caregiver to turn the patient to the left or right. The **Right Turn** control turns the patient to the patient's right side.

The siderail that the patient is turning **towards** MUST be in the **up** position to activate Turn Assist. If the siderail is down, a triple beep will sound, and a message will show on the touchscreen to let you know that the siderail is lowered. Raise the rail, and press **Turn Assist**. Once the patient starts to turn, the siderail the patient is turning away from can be lowered for easier patient access. A beep will sound as a safety alert and a 15-minute countdown will show on the touchscreen when the mattress reaches the full turn.

Turn Assist mode can be stopped during inflate or deflate by pressing **Stop Turn** on the touchscreen.

### Before You Activate Turn Assist

- Make sure to remove these items from the bed:
  - USB cord from the siderail
  - Patient pendant from the inside of the siderail
  - Any loose items on the mattress
- Level the knee and foot sections of the bed.
- Straighten the patient's legs.
- Lower the head section below 25°.

### To Activate

1. Press the **Mattress** menu control.
2. If a personal electronic device is plugged into the USB port, unplug the device from the siderail.
3. Press **Continue**.
4. If the bed is not in the correct position to do Turn Assist, this screen will show. Press **Adjust Bed Button** to correct the bed's position.

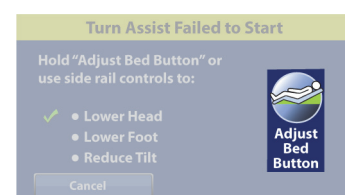
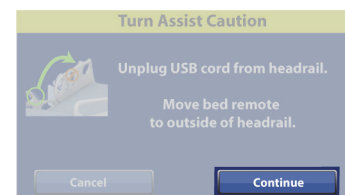

5. Press **Right Turn** or **Left Turn**. The control turns **green** when Turn Assist is active.

- To stop Turn Assist, press **Stop Turn**.
- To hold the turn at less than the full angle, press **Stop Turn** while the mattress is inflating. Press **Resume** to continue the turn.
- To deactivate the turn, press **Normal**.

After 15 minutes in a turned position, a beep will sound, and the mattress will return to Normal mode.

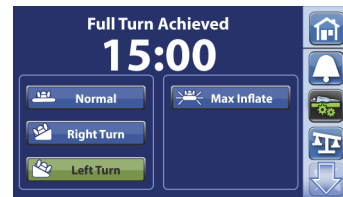
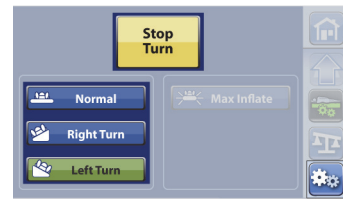

**NOTE:**

Turn Assist will deactivate, the turn assist bladders will deflate, and the mattress will return to Normal mode if—

- The siderail the patient is turning towards is lowered.
- The head section is raised above 25°.

**To Deactivate Turn Assist before the Mode Times Out**

- Press **Normal**.



**Continuous Lateral Rotation (CLR)**

The rotation mode provides gentle, side-to-side, continuous lateral rotation (CLR). Patients can be positioned laterally on the right or left side with varying amounts of turn and pause times to match each individual patient’s condition. Pressure redistribution is provided when the rotation mode is active.

The recommended weight range for pressure relief and turning capabilities is 70 to 500 lbs (32 to 227 kg).



**CONTRAINDICATION:**

**Contraindication**—Use of Continuous Lateral Rotation for patients with unstable spinal cord injury could cause serious injury to the patient.

**Contraindication**—Use of Continuous Lateral Rotation is contraindicated for patients with cervical or skeletal traction.

**WARNING:**

To help prevent injury and/or equipment damage, obey these **warnings**:

- **Warning**—Use care when you transfer a patient from the bed to another surface.
- **Warning**—Operating Rotation at higher than typical settings may cause elevated surface temperatures and patient harm. For example, the combination of the following control settings:
  - Rotation set to Full with a 3 minute center pause time
  - Rotation operating continuously
- **Warning**—The patient may move laterally on the surface when rotation is active.
- **Warning**—Observe lines closely during rotations and/or patient positioning. Always use good line management techniques to prevent lines and tubing from becoming dislodged during rotation and/or patient positioning.
- **Warning**—During rotation, monitor patient position and make sure that the patient stays centered on the mattress with hips correctly aligned and that there is sufficient slack in the lines for patient movement and mattress rotation.
- **Warning**—Make sure that all siderails are in the raised position and fully latched.
- **Warning**—Do not use continuous lateral rotation with the head of bed raised above 35 degrees.
- **Warning**—Do not use continuous lateral rotation with the knee raised above 20 degrees.
- **Warning**—Do not use continuous lateral rotation with the bed in a tilted position (Trendelenburg or Reverse Trendelenburg) above 10 degrees.
- **Warning**—Do not use continuous lateral rotation with the foot section fully raised.
- **Warning**—Do not use continuous lateral rotation with the USB charging port in use.
- **Warning**—The accuracy of the Heart and Respiration Rate Monitoring System, while using continuous lateral rotation, may be reduced.
- **Warning**—Store the patient pendant on the outside of the siderail during continuous lateral rotation.
- **Warning**—The WatchCare (incontinence) alert for a soiled pad could be delayed when the rotation feature is in use.

**Rotation Reminders:**

- Rotation therapy will be suspended when:
  - Any siderail is lowered. To restart rotation, raise siderail to the up and locked position.
  - Head of Bed (HOB) is raised higher than 35 degrees with respect to level. To restart rotation, lower HOB.
  - Foot of Bed (FOB) is raised more than 30 degrees. To restart rotation, lower FOB.
  - Knee is raised more than 20 degrees. To restart rotation, lower the knee.
  - Tilted position (Trendelenburg or Reverse Trendelenburg) is greater than 10 degrees. To restart rotation, decrease tilt position.
  - The USB charging port is in use. To restart rotation, unplug cable from the charging port.
  - Max-Inflate or Turn Assist is active. To restart rotation, turn off Max-Inflate or Turn Assist.

**NOTE:**

The recommended bed position for use with continuous lateral rotation is:

- HOB at 30 degrees
  - Knee at 15 degrees
  - Tilt (Trendelenburg or Reverse Trendelenburg) at 0 degrees (level)
- A message will show on the GCI when CLR has been suspended for any of the above conditions.
  - If CPR is activated, rotation automatically stops and Max-inflate is activated. If Max-inflate is active for 60 minutes the mattress will return to normal mode and not the previous mode.
  - Check the GCI screen if you are uncertain why the bed is beeping - the reason will be displayed on the GCI screen.

**Setup**

1. Put the patient on the bed.
2. Raise all siderails to the up and locked position. A click will be heard when it latches into the locked position.

Rotation Preview

Rotation preview is used to check the movement of the patient and the lines and to observe the patient’s condition before beginning rotation.

1. Press the **Settings** menu control on the GCI.
2. Press **Rotation**.
3. Press **Enable** to enable rotation, and then press **Accept**.
4. Press **Full** or **Moderate** and then move the hold time slider bar to the applicable setting.
5. Press **Preview** to begin Rotation Preview.

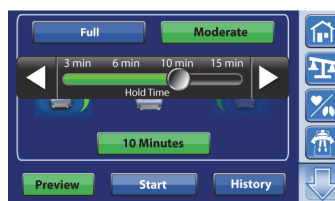
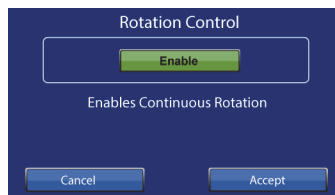
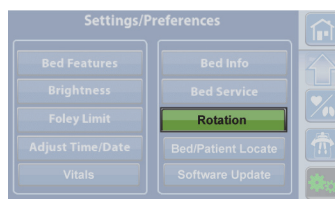

6. Follow the on-screen instructions and press **Preview**.

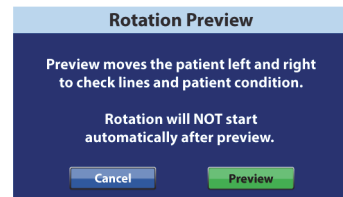

7. When preview is complete, press **Stop Preview**.



8. Press **Cancel** to return to the rotation settings screen or press **Resume Preview** to return to rotation preview.

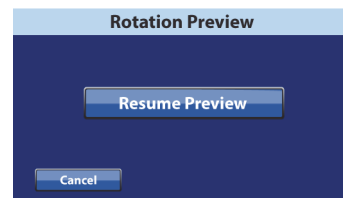

Start Rotation

1. Press the **Settings** menu control on the GCI.



2. Press **Rotation**.

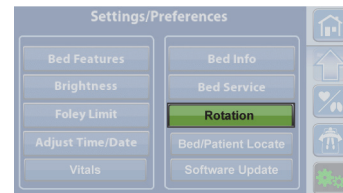

3. Press **Enable** to enable rotation, and then press **Accept**.

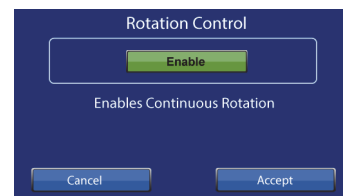

4. Press **Full** or **Moderate** and then move the hold time slider bar to the applicable setting.

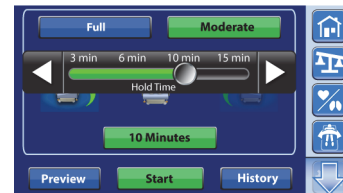

5. Press **Start** to begin Rotation.

**NOTE:**

If Rotation is desired with Bed Exit on, Bed Exit must be turned on before Rotation is started. Only Out of Bed Mode will work during Rotation.

## Stop Rotation

1. Press the **Pulmonary** menu control on the GCI.
2. Press **Stop Rotation**.
3. Press **Yes** to stop rotation.



## Rotation History

To view the rotation history:

1. Press the **Settings** menu control on the GCI.
2. Press the **Rotation** menu control on the GCI.
3. Press **Enable** to enable rotation and then press **Accept**.
4. Press **History**.

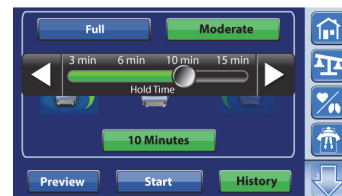
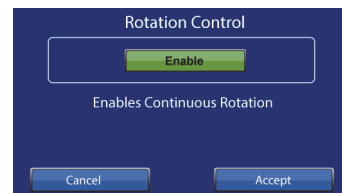
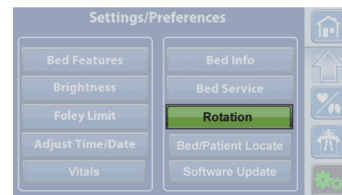

## X-Ray Sleeve



### WARNING:

**Warning**—When anything is inserted within the x-ray sleeve, the HR/RR monitoring system may not be accurate and should not be depended upon or patient injury could occur.

An x-ray cassette sleeve is available on the **Centrella** max and pro+ mattresses. The caregiver can insert a cassette into the sleeve from either side of the mattress through a zipper pocket in the top cover.

To use the sleeve, do as follows:

1. Make sure the brake is set.
2. Make sure the bed is plugged into AC power.
3. Make sure the head of the bed is at least 30°. You may adjust this position for patient comfort.



4. Put the mattress in the Normal mode; do as follows:
  - a. Press the **Mattress** menu control on the GCI.
  - b. Press **Normal**.
5. Pull the sheet away from the edge of the mattress.
6. Lift the top cover zipper flap to get access to the sleeve zipper.



**CAUTION:**

**Caution**—Use caution when you operate the zipper or equipment damage could occur.

7. Unzip the sleeve.

**CAUTION:**

**Caution**—The sharp edges of an x-ray cassette can damage the mattress. Use care when you use an x-ray cassette with the mattress.

8. Make sure the x-ray cassette is in a plastic bag or similar covering.
9. Insert the x-ray cassette.
10. Remove the x-ray cassette when finished.
11. Zip the x-ray sleeve to close.
12. Make sure the x-ray sleeve zippers are closed on both sides of the mattress.
13. Make sure the top cover zipper flaps cover the x-ray sleeve zippers.

**NOTE:**

If it is difficult to insert the cassette, reduce the weight on the sleeve. To do so, raise the head of the bed and have the patient lean forward or have a second person assist, as appropriate for the clinical situation.

## Mattress Removal

1. Set the brake.
2. Adjust the bed to a comfortable working height.
3. Adjust the bed to the flat position.
4. Fully extend the foot section.

**WARNING:**

**Warning**—Failure to remove power from the bed could cause injury or equipment damage.

5. Unplug the bed.
6. Lower the siderails.
7. Disconnect the mattress's four attachment knobs from the bed frame.
8. If the bed has the pro+ mattress (P7923A), see the *pro+ Mattress Instructions for Use* (209196) to remove the mattress. If the bed has the **Centrella** max mattress (P7922A), do as follows. Otherwise, go to Step 9.
  - a. Fold the foot end of the mattress assembly over the head end.

- b. Pull up on the heel cover (A) to release it, and then turn it as necessary to fully disconnect the cover from its opening.
- c. Pull the cover (A) back toward the sleeve to get access to the pneumatic box connection.
- d. Disconnect the interface connector assembly (B) from the pneumatic box.

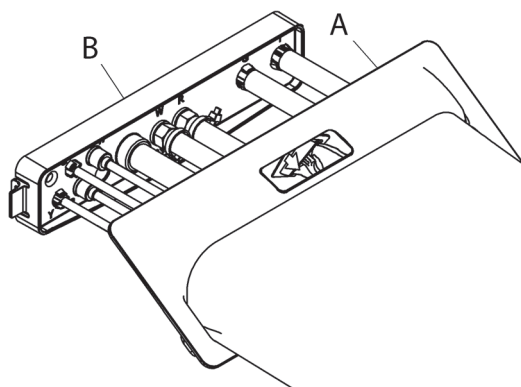

**NOTE:**

To disconnect the interface connector assembly, it may be helpful to insert a small screwdriver between the connector assembly and its latch tabs.



**CAUTION:**

**Caution**—Failure to keep the pneumatic box covered when the interface connector assembly is disconnected could cause equipment damage.

- e. Pull the pneumatic box cover (C) over the pneumatic box (D). Keep the interface connector on the pneumatic box covered until you connect the interface connector assembly.



9. Remove the mattress from the bed.

---

## TRANSPORT THE PATIENT

### TRANSPORT SAFETY INFORMATION



**WARNING:**

To help prevent injury and/or equipment damage, obey these **warnings** when you transport a patient in the bed:

- **Warning**—If the bed is stopped on a ramp, set the brake to avoid unwanted bed movement.
- **Warning**—During transport, use caution so that the bed does not tip or overbalance.
- **Warning**—Unless you are to transport a patient, always set the brakes when the unit is occupied. Make sure the brakes are set before any patient transfer on to or off the bed.
- **Warning**—Do not transport a patient with the bed in the Chair position.
- **Warning**—Do not use the **powered transport system** if the bed moves forward or reverse when one of these occur. Contact your facility-authorized maintenance person or Hill-Rom Technical Support.
  - You press one of the enable switches, but do not apply pressure to one of the handles.
  - You apply pressure to one of the handles, but do not press one of the enable switches.

**CAUTION:**

To help prevent equipment damage, obey these **cautions** when you transport a patient in the bed:

- **Caution**—Before transport, make sure that the power cord, hoses, and other equipment are correctly stored.
- **Caution**—Do not push or pull the bed by IV poles, siderails, or other equipment. Use the push handles, headboard, or footboard.
- **Caution**—The **powered transport system** is intended for indoor use only. Outdoor use may cause temporary or permanent damage to the powered drive mechanism.
- **Caution**—For transport, a fully-charged **bed** battery is preferred; however, if the bed battery charge is low, put the bed in the transport position before any transport, and connect the bed to AC power as soon as possible
- **Caution**—Do not attempt a powered transport unless there is a minimum of a single bar on the powered transport battery indicator that is on the Transport Pod.

**NOTES:**

- If a **Centrella** max mattress is on the bed, the mattress will stay inflated during the transport but will **not** provide pressure redistribution. To help with lateral transfers, **Max Inflate** the mattress before you unplug the bed from the AC power; the mattress will then stay firm.
- For a bed without the powered transport system, you may put the bed in either Steer or Neutral for the transport.
- The batteries for the bed controls and for the optional powered drive system get charged only when the bed power cord is plugged into an AC power outlet; therefore, we recommend that you plug the bed into a power outlet whenever possible.

**Powered Transport Only**

- If no bars show on the battery indicator that is on the Transport Pod, the battery is too low for transport. Either plug the bed in to charge the battery or put the bed in **Neutral** to transport the patient.
- When the bed is moving at full speed, a sudden release of the enable switches will cause the bed to stop abruptly.
- A sudden change in direction of the push handles (push/pull; forward/backward) will cause the bed to stop abruptly.
- If the bed is difficult to move, it may be that the powered drive system is not correctly engaged. Make sure that the bed is in steer and the battery indicator shows at least one bar.

- If the bed does not move when the bed is in steer, the enable switch is pressed, and pressure is applied to the handle(s), make sure the mechanical override is not engaged (the handle on the power drive module's foot end is completely pushed in).



## PREPARE THE BED FOR TRANSPORT

1. Raise all four siderails to the up and locked position.
2. Shorten the length of the bed if necessary.
3. Adjust the head section to make sure the view is not obstructed from the head end of the bed.
4. Secure all hoses and equipment (such as monitors, oxygen tanks, and IV poles) that are to be transported with the bed.
5. If the Patient Helper or **Experience Pod** Device accessory is installed, make sure that it will not impact doorways or ceiling fixtures.
6. Lower the IV poles as necessary so that they do not impact doorways or ceiling fixtures.
7. Unplug and store the power cord, and as applicable, the auxiliary outlet power cord and the communication cable.
8. Put the bed in **Steer**.
9. If the bed has push handles, lift the handles up, and drop them into the locked position.

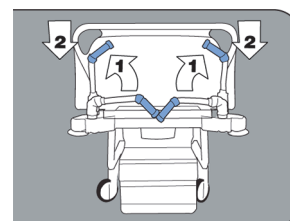

## TO TRANSPORT

- Bed **without** powered transport—transport the patient per facility protocol.
- Bed **with** powered transport—continue to “Use the Powered Transport System” below.

## Use the Powered Transport System

1. At the Transport Pod, look at the battery indicator, and make sure that at least one bar shows.



2. Adjust the transport pod into a position for easy access.

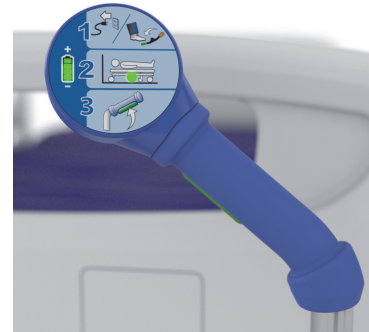

3. Do these steps as shown on the Transport Pod:

- a. Make sure that the power cord is **unplugged**, (and as applicable, the auxiliary outlet power cord and the communication cable), and then step down on the green pedal to put the bed in **Steer (1)**.
- b. Listen for the power drive wheel to lower. When the wheel has fully lowered, the wheel indicator on the Transport Pod will turn green **(2)** and a beep will sound.
- c. Grip one or both of the push handles, and then press and hold at least one of the enable switches that are on the **underside of the blue push handles (3)**.
  - When pressed, the enable switch prepares the transport system to move the bed when pressure is applied to the handles.
  - The bed will not move until pressure is applied to the handles.

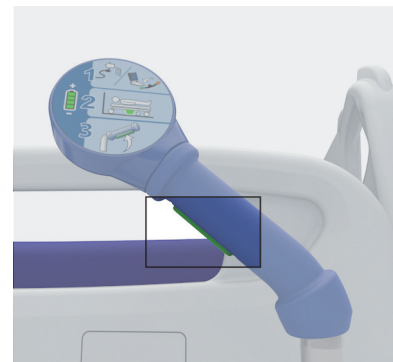
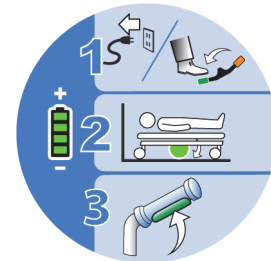

4. To move the bed, push the push handles forward to start forward movement or pull them backward to start reverse movement:
  - The amount of pressure applied to the handles will regulate the speed of the bed. Increasing the forward applied pressure will move the bed forward faster. Increasing the reverse applied pressure will move the bed in reverse faster.
  - A gradual decrease of pressure on the push handles will **slow** the bed.
5. Transport the patient per facility protocol.

### Power Loss during Transport

A mechanical override is located on the foot end of the **IntelliDrive** Transport System. If the battery fails or there is a loss of the motor power during a transport, pull the mechanical override towards the foot end.



In the event that the system loses power during a transport, do as follows:

1. Set the brake.
2. Get additional persons to help manually transport the bed.
3. Put the bed in **Neutral** to raise the drive wheel off the floor.

or

Pull the mechanical override towards the foot end of the bed to permit manual movement of the bed with the power drive wheel lowered.

4. Continue with the transport.

### **AFTER TRANSPORT**

1. When the bed is in the correct position, set the **brake**. On a bed with the powered drive system, the drive wheel will raise off the ground and the drive wheel indicator on the Transport Pod will turn off.

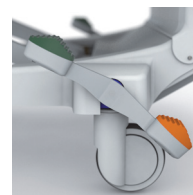

2. Plug in the power cord, and as applicable, the auxiliary outlet power cord and the communication cable.
3. Adjust the IV poles to the correct working height.
4. Optional: To store the push handles, pull them upward to unlock them, and then swing them inward (toward the center of the bed) into the stored position.

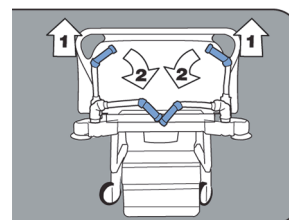

## ACCESSORIES

Part Number	Description
P7512	Line Managers
P2217	IV Pole
P7511	Permanent IV Pole
P158	Infusion Support System
P7524	Transport shelf
P7934 or P7936	Patient Helper
P7928 or P7938	Patient Helper support
P7939	HD Patient Helper mount
P3212	Patient Helper sleeve
P276A and P009408	O2 tank holder
P7927 or P7937	Traction frame
P7929	Push Handles

### LINE MANAGERS (P7512)



#### WARNING:

**Warning**—Do not use the line managers to secure ventilator tubing; use only approved ventilator tubing devices. To do so could cause personal injury or equipment damage.



#### CAUTION:

**Caution**—Do not wrap power cords around the line managers. Otherwise, equipment damage could occur.

The line managers help keep lines such as IVs, suction tubing, and monitor cables together and away from the articulation of the frame.

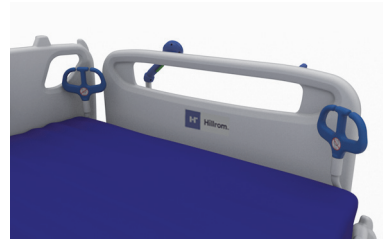

### IV POLES (P2217 AND P7511)



#### WARNING:

To help prevent personal injury or equipment damage, obey these **warnings**:

- **Warning**—Do not exceed the 10 kg (25 lb) load capacity of the IV pole (P2217).
- **Warning**—Do not exceed the 18 kg (40 lb) load capacity of the IV pole (P7511).
- **Warning**—The head-end equipment sockets do not move up and down with the sleep deck. Use appropriate precautions with gravity-sensitive devices such as ventricular drains or lumbar drains before, during, and after operating bed functions.

- **Warning**—Correctly attach the IV pole; otherwise, it may fall.
- **Warning**—Uneven loading of the IV pole could cause the contents to fall.
- **Warning**—When you lower the upper section of an IV pole, always hold the upper section of the pole before you pull the release knob.
- **Warning**—Install the IV pole in an equipment socket only (see “Equipment Sockets” on page 22).



### Removable IV Pole (P2217)

The IV pole is a removable, telescopic pole that installs in any of the equipment sockets.

#### To Install

Insert the IV pole vertically into any of the equipment sockets at either the head end or foot end of the bed.

#### To Remove

Pull the IV pole out from the equipment socket.

### Permanent IV Pole (P7511)

#### To Use

1. Lift the IV pole from its stored position behind the headboard and raise the pole straight up.
2. Make sure that the pole drops into the locked position.
3. Raise the upper section of the pole to the desired height.

#### To Store

1. Hold the upper section of the IV pole. Push the upper collar down and lower the upper pole section into the lower pole section.
2. Lift the lower section of the IV pole up and lower the pole down to the stored position behind the headboard.

### INFUSION SUPPORT SYSTEM (P158)



#### **WARNING:**

To help prevent personal injury or equipment damage, obey these **warnings**:

- **Warning**—Do not exceed the 9 kg (20 lb) load capacity (safe working load) of the infusion support system (ISS) pole.
- **Warning**—Correctly attach the ISS pole; otherwise, it may fall.
- **Warning**—Uneven loading of the ISS pole could cause the contents to fall.





- **Warning**—When you lower the upper section of an ISS pole, always hold the upper section of the pole before you pull the release knob.

The Infusion Support System (ISS) consists of a movable and adjustable IV pole. The pole supports IV pumps or bags in a vertical orientation and raises or lowers the pumps or bags with respect to the bed frame.

The head end of the bed has attaching points for two mobile ISS poles. Each pole can support one infusion pump plus two liters of intravenous solution.

Before you install the ISS pole (P158), you must install the P163 ISS socket adapter.

## TRANSPORT SHELF (7524)



### WARNING:

To help prevent personal injury or equipment damage, obey these **warnings**:

- **Warning**—Do not exceed the 20.4 kg (45 lb) safe working load of the transport shelf. To do so could cause the shelf to fail.
- **Warning**—The foot section must be flat for you to use the transport shelf.
- **Warning**—Do not stand or sit on the transport shelf.
- **Warning**—Failure to use the straps to hold equipment on the shelf could permit the equipment to fall.
- **Warning**—When the footboard is removed from the bed, do not lay the footboard flat on the floor. Store the footboard in a position or location that it does not come in contact with biohazards.

### NOTE:

The footboard with the transport shelf installed can be put against a wall in a position so that it will not fall.

The transport shelf can be used to hold small equipment during patient transport and as a writing surface.

### To Use

1. Make sure the foot section is flat.
2. Lift the shelf up and over the footboard toward the mattress until the shelf stops in the horizontal position.



### To Store

1. Remove all the equipment from the shelf and connect the hook and loop straps.
2. Lift the shelf up and over the footboard away from the mattress until the shelf is flat against the footboard and is locked in position.



### OXYGEN TANK HOLDER, E-SIZE (P276A) HX OR F-SIZE (P009408) PATIENT HELPER



#### WARNING:

To help prevent injury and/or equipment damage, obey these **warnings**:

- **Warning**—Failure to correctly attach the oxygen tank holder could cause it to drop. Injury or equipment damage could occur.
- **Warning**—If the oxygen tank holder is placed at the foot end of the bed, make sure the Foot and Knee Up/Down controls are locked out. Failure to do so can result in caregiver, patient, or visitor injury if the foot section fully lowers and the holder becomes dislodged from the bed.
- **Warning**—When the bed is articulated and the oxygen tank holder is placed at the foot end of the bed, make sure the extremities of the caregiver, patient, or visitor are clear of the area around and underneath the oxygen tank holder.

The P276A oxygen tank holder holds one **D** or **E** size oxygen tank with a regulator. The P009408 oxygen tank holder holds one HX or F size oxygen tank with regulator. The mount location lets the affixed oxygen tank holder pivot. The safe working load of the P276A oxygen tank holder is 14 kg (30 lb). The safe working load of the P009408 oxygen tank holder is 20.4 kg (45 lb).



#### To Install

1. Install the mounting bar vertically into any of the equipment sockets at either the head end or foot end of the bed.
2. Put the oxygen tank in the oxygen tank holder.

#### NOTES:

- Make sure that when you put an oxygen tank in a head-end holder the tank does not interfere with the head section articulation.
- If the holder is placed at the foot end of the bed, make sure the holder does not contact the ground when lowering the bed.

#### To Remove

1. Lift the oxygen tank out of the oxygen tank holder.
2. Lift up on the oxygen tank holder and remove it from the equipment sockets.

### (P7934 OR P7936)

**WARNING:**

To help prevent personal injury and /or equipment damage, obey these **warnings**:

- **Warning**—Do not exceed the 113.5 kg (250 lb) load capacity of the Patient Helper arm assembly.
- **Warning**—Correctly attach the Patient Helper arm assembly; otherwise, it may fall.
- **Warning**—Do not remove or install the Patient Helper arm assembly while it is in a position over a patient.
- **Warning**—Use correct lifting techniques and /or ask for assistance when you install or remove the Patient Helper.

The Patient Helper can be used to help assist patients with mobility.

**To Install**

1. Make sure the bed's brake is set and a patient is not in the bed.
2. Lower the bed to its lowest position.

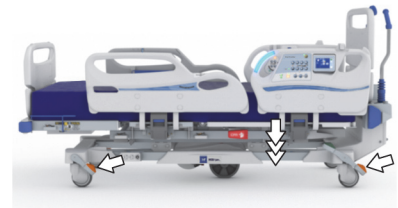
**NOTE:**

There are two versions of the patient helper mounts. Both versions are shown in the following steps to assist you in the installation of your version.

3. Remove the pull pin from the Patient Helper mount on the head end of the bed.
4. Install the arm assembly into the Patient Helper mount. Make sure the arm assembly is fully inserted in the mount.

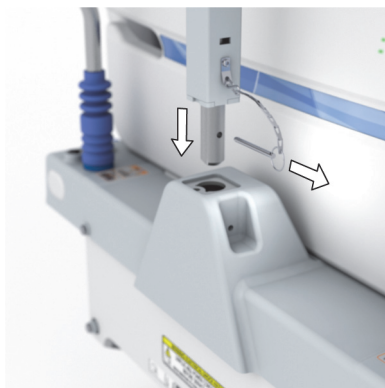

5. Insert the pull pin to hold the Patient Helper arm assembly in position.



6. Install the horizontal arm into the arm assembly and insert the pin to hold the horizontal arm in position.

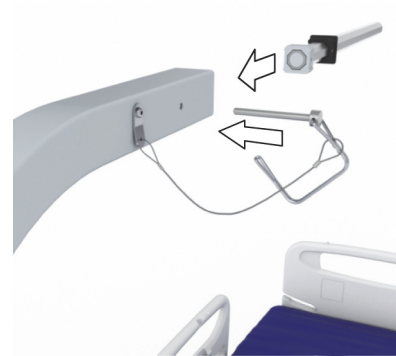

7. Install the retainer on to the pin.

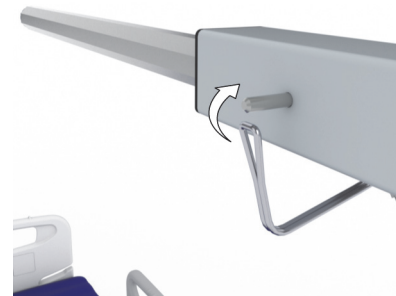

8. Make sure the pin is through the retainer.



9. Install the clamp of the trapeze handle assembly on to the horizontal arm and tighten the clamp to attach the trapeze handle assembly to the horizontal arm.



### To Remove

1. Loosen the clamp that attaches the trapeze handle assembly to the horizontal arm and remove the trapeze handle assembly from the horizontal arm.
2. Remove the pull pin, and then remove horizontal arm from the assembly.
3. Remove the pull pin, and then remove arm assembly from the Patient Helper mount.
4. Insert the pin into the Patient Helper mount.

### PATIENT HELPER BRACKET SUPPORT (P7928) AND PATIENT HELPER SLEEVE (P3212)



#### WARNING:

**Warning**—Do not exceed the 113.5 kg (250 lb) load capacity of the Patient Helper Bracket Support. Injury or equipment damage could occur.

The patient helper bracket support (P7928) is for use with patient helper sleeves from traction equipment manufacturers.

The patient helper sleeve (P3212) must be installed before the adapter bracket is installed on the bed. Refer to the equipment manufacturer's instructions for installation procedures. The P3212 patient helper sleeve is for use with the Orthopedic System, Inc. patient helper.



## PATIENT HELPER BRACKET SUPPORT (P7938) AND PATIENT HELPER SLEEVE (P3212)

### WARNING:

**Warning**—Do not exceed the 113.5 kg (250 lb) load capacity of the Patient Helper Bracket Support when used with the Patient Helper Sleeve. Injury or equipment damage could occur.

The patient helper bracket support is for use with patient helper sleeves from traction equipment manufacturers.

The patient helper sleeve (P3212) must be installed before the adapter bracket is installed on the bed. Refer to the equipment manufacturer's instructions for installation procedures.

The P3212 patient helper sleeve is for use with the Orthopedic System, Inc. patient helper.

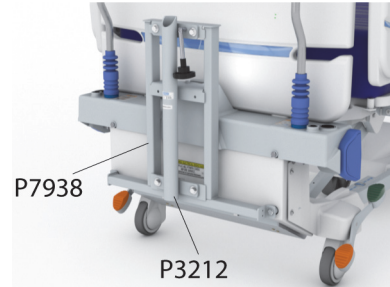

## PATIENT HELPER BRACKET SUPPORT (P7938) AND HD PATIENT HELPER MOUNT (P7939)

### WARNING:

**Warning**—Do not exceed the 127 kg (280 lb) load capacity of the Patient Helper Bracket Support when used with HD Patient Helper Mount. Injury or equipment damage could occur.

The patient helper bracket support (P7938) is for use with patient helper sleeves from traction equipment manufacturers.

The HD patient helper mount P7939 must be installed before the adapter bracket is installed on the bed. Refer to the equipment manufacturer's instructions for installation procedures.

The P7939 HD patient helper mount is for use with the Zimmer HD patient helper.

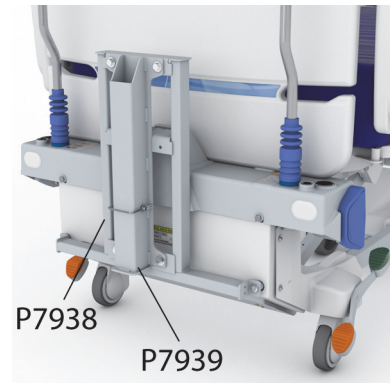

## TRACTION FRAME (P7927 OR P7937)

### WARNING:

To help prevent injury and/or equipment damage, obey these **warnings**:

- **Warning**—The sleep deck moves independently of the bed frame. Failure to account for the sleep deck movement when using fracture frames and/or traction equipment can cause serious injury or death.
- **Warning**—Do not exceed the 113.5 kg (250 lb) load capacity of the Traction Frame.

The Traction Frame permits the bed to be used with traction equipment.

For safe installation and operation, refer to the traction equipment manufacturer's installation and operation instructions.



### PUSH HANDLES OPTION

The push handles at the head end of the bed can be used to steer the bed and adjust the bed's position.

**To stow the push handles**—pull them upward to unlock them, and then swing them inward (toward the center of the bed) into the stowed position.

**To use the push handles for transport**—lift the handles up, and drop them into the locked position.

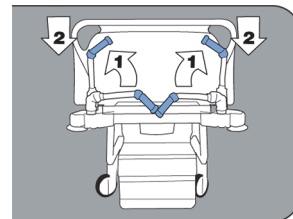
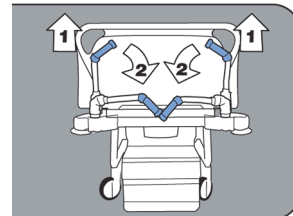

## CLEANING AND DISINFECTING

### NOTE:

If the bed has the pro+ mattress (P7923 and P7924), see the *pro+ Mattress Instructions for Use* (209196) to clean and disinfect the mattress.



### WARNING:

To help prevent injury and/or equipment damage, obey these **warnings**:

- **Warning**—The potential for electrical shock exists with electrical equipment. Failure to follow facility protocol could cause death or serious injury.
- **Warning**—Do not reuse wiping material for multiple steps or on multiple products.
- **Warning**—Harmful cleaning solutions may cause skin rash and/or irritation upon contact. Follow the manufacturer's instructions found on the product label and Safety Data Sheet (SDS).
- **Warning**—Lift and move items correctly. Do not twist, and seek assistance when necessary. Make sure the bed is at a correct height to lift items off the bed.

- **Warning**—Fluid spills on to the bed electronics could cause a hazard. If such a spill occurs, unplug the bed and remove it from service. When fluid spills occur outside of what is seen in normal use, immediately do as follows:
  - a. Unplug the bed from its power source.
  - b. Remove the patient from the bed.
  - c. Clean the fluid spill from the bed system.
  - d. Have maintenance examine the system completely.
  - e. Do not put the bed back into service until it is completely dry, tested, and found to be safe to operate.



**CAUTION:**

To help prevent equipment damage, obey these **cautions**:

- **Caution**—Do not steam clean or power wash the bed. Pressure and excessive moisture can damage the protective surfaces of the bed and its electrical components.
- **Caution**—Do not use harsh cleansers/detergents, heavy duty grease removers, solvents such as toluene, xylene, or acetone, and do not use scouring pads (you may use a soft bristle brush).
- **Caution**—Do not use bleach as your primary everyday cleaner/disinfectant.
- **Caution**—Fully extend the foot section prior to the cleaning and disinfection process.

## RECOMMENDATIONS

For proper cleaning and disinfection, staff members should be trained.

The **trainer** should carefully read the instructions and follow them when the **trainee** is being trained.

The trainee should:

- Be given time to read the instructions and to ask any questions.
- Clean and disinfect the product while the trainer supervises. During, and/or after this process, the trainer should correct the trainee of any differences from the instructions for use.

The trainer should supervise the trainee until the trainee can clean and disinfect the bed as instructed.

Hill-Rom recommends to clean and disinfect the bed and mattress before first patient use, between patient use, and regularly during extended patient stays.

Some fluids used in the hospital environment, such as iodophor and zinc oxide creams, can cause permanent stains. Remove temporary stains by wiping vigorously with a lightly dampened wiping cloth.

## CLEANING AND DISINFECTION

Cleaning and disinfection are distinctly different processes. **Cleaning** is the physical removal of visible and non-visible soil and contaminants. **Disinfection** is intended to kill microorganisms.

Table 1 below summarizes the approved cleaners/disinfectants for use with the associated contact time for disinfection.



**Table 1: Approved Cleaners/Disinfectants**

<b>Cleaner/Disinfectant</b>	<b>Recommended for Routine Cleaning and Disinfection</b>	<b>Recommended for Disinfection against Clostridium Difficile (C.Diff)</b>	<b>Maintain Wetness (Disinfection Contact Time)</b>
<b>Wex-Cide</b> Germicidal Detergent ready-to-use	Yes	No	10 minutes
<b>Virex II 256</b>	Yes	No	10 minutes
<b>OxyCide</b> Daily Disinfectant Cleaner	Yes	Yes	3 minutes
<b>Clorox HealthCare</b> Bleach Germicidal Cleaner ready-to-use	<b>No*</b>	Yes	3 minutes
<b>Clorox HealthCare</b> Bleach Germicidal Wipes	<b>No*</b>	Yes	3 minutes
<b>Oxivir</b> TB (FRAME ONLY)	Yes	No	10 minutes

\*Bleach is not recommended as the primary cleaner/disinfectant.

**Remove any disinfectant residue prior to and after the use of bleach** with a new or clean cloth/wipe soaked in tap water.

**NOTE:**

Not all cleaners and disinfectants listed in Table 1 may be approved for sale in your country. Always refer to the local regulations for applicable approved, listed in Table 1, cleaners and disinfectants. For questions, contact your Hillrom representative.

When you perform the detailed cleaning steps, please note the following:

- A microfiber cloth or the **Clorox HealthCare** Bleach Germicidal Wipe is recommended as the wiping cloth.
- Always replace the wiping cloth when visibly soiled.
- Always replace the wiping cloth between steps (spot clean, clean, and disinfect).
- Always use Personal Protective Equipment (PPE).
- Adjust the bed position, siderails, headboard, and footboard as needed for ease of cleaning and disinfection.

**Prepare the Bed for Cleaning and Disinfecting**

- a. Fully extend the foot section.
- b. Unplug the bed.

**STEP 1: Cleaning**

- a. As necessary, first remove visible soil from the bed and the mattress using a wiping cloth soaked with an approved cleaner/disinfectant (see "Table 1: Approved Cleaners/Disinfectants" on page 131).
  - Give special attention to seams and other areas where soil may accumulate.
  - A soft bristle brush may be used to loosen hardened soil.
  - Use as many wiping cloths as needed to remove the soil.

**NOTE:**

If desired, the **Centrella** max mattress cover may be removed and laundered to remove visible soil. See "Laundry Guidelines" on page 134.

It is important to remove all visible soil from all areas before continuing to remove non-visible soil.

- b. With a new wiping cloth soaked in an approved cleaner/disinfectant, use firm pressure to wipe all surfaces of the bed and mattress (including laundered covers). Use a new or clean wiping cloth as often as necessary. Make sure the following items are cleaned:
- Siderails and under the GCI
  - USB charging port
  - Headboard and footboard
  - Areas between the footboard and mattress, headboard and mattress, and siderails and mattress
  - Upper frame
  - Base frame
  - Power cord
  - Patient pendant (handheld remote) and pendant cord
  - Accessories (See "Accessories" on page 121.)
  - **Experience Pod** Device
    - Clean the entire **Experience Pod** Device. Give special attention to the areas indicated in the picture below.

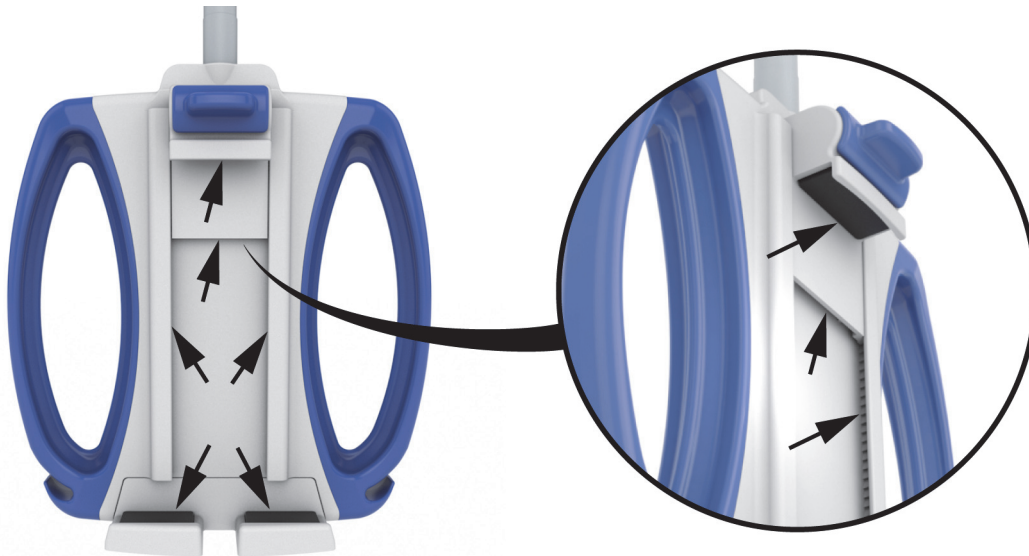

- Mattress - top and bottom
- X-ray cassette sleeve
  - Clean the inside of the x-ray cassette sleeve. Give special attention to the area indicated in the picture below.



- To raise the mattress to clean underneath, find the mattress retention knobs on the underside of the mattress, and slide the knobs to the center of bed.
  - Clean the “bladder fold” area indicated in the picture below (**Centrella** max mattress).
  - Clean the sensor and cord for the HR and RR Monitoring System.

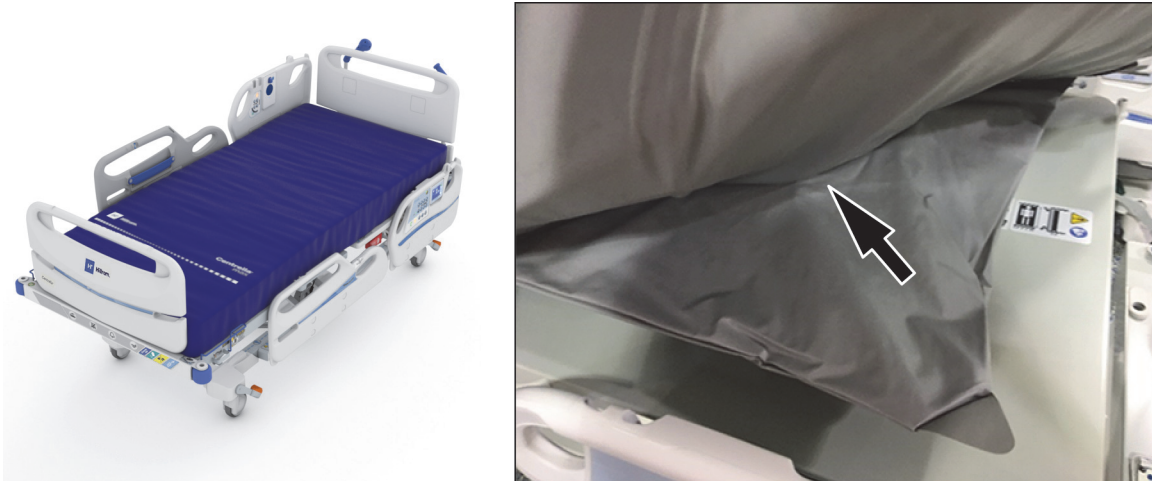

- Clean the interface connector assembly and the mattress sleeve area indicated in the picture below (**Centrella** max mattress). Do not disconnect the connector.

**NOTE:**

Clean the folds of the mattress sleeve.



- c. Examine the following for damage:
  - Top mattress cover
  - Bottom mattress cover and white attachment knobs
  - Zipper closure
- d. The damaged items should be replaced.

**STEP 2: Disinfection**

- a. With a new or clean wiping cloth soaked in an approved cleaner/disinfectant, use light pressure to wipe all exterior surfaces of the bed previously cleaned.
- b. Make sure all surfaces **remain wet with the cleaner/disinfectant** for the **specified contact time**. **Re-wet** surfaces with a new wiping cloth as necessary. See “Table 1: Approved Cleaners/Disinfectants” on page 131 for the contact time.

**NOTE:**

If bleach is used with another cleaner/disinfectant, use a new or clean cloth/wipe soaked in tap water to remove any disinfectant residue prior to and after the bleach application.

**Prepare the Bed for Use**

- a. Connect the mattress retention knobs at the head and foot ends of the mattress.
- b. Plug the bed into an applicable power outlet.

**LAUNDRY GUIDELINES**

Laundry can be used as a **pre-cleaning** step for the **Centrella** max top mattress cover. Launder the cover, then follow the Cleaning and Disinfection instructions.

**NOTES:**

- The **Centrella** pro or core mattress covers **cannot** be laundered.
- Do **not** use bleach.

Machine wash the top cover as follows:

- a. Unzip and remove the top cover from the mattress.

**NOTE:**

The zipper tabs are located on the left side at the head end of the mattress.

- b. Machine wash the top cover per your facility protocol. The cover can be washed at a maximum water temperature of 54°C (130°F).
  - Use a disinfectant as instructed in the manufacturer’s instructions.
  - To determine the amount of disinfectant to use, determine the amount of water in the washer, and follow the manufacturer’s dilution instructions.
  - During the wash cycle, soak the top cover in the disinfectant.
  - Let the top cover rinse thoroughly in clean water.
- c. Use the lowest temperature setting of the dryer to dry the top cover; do not exceed 43°C (110°F).
- d. Follow the Cleaning and Disinfecting instructions. See “Cleaning and Disinfecting” on page 129.

For **rental** beds, Hill-Rom Service personnel will follow the Laundry Wash and Dry Procedure (QS02040).

---

## PREVENTIVE MAINTENANCE

**WARNING:**

**Warning**—Only facility-authorized persons should service the **Centrella** Smart+ Bed. Service done by unauthorized persons could cause injury or equipment damage.

The **Centrella** Smart+ Bed requires an effective maintenance program. We recommend that you do annual preventive maintenance (PM) for Joint Commission certification. PM not only meets Joint Commission requirements but can help make sure of a long, operative life for the **Centrella** Smart+ Bed. PM will help minimize downtime due to excess wear. For a preventive maintenance schedule, refer to the *Centrella Smart+ Bed Service Manual* (193588).

If the bed has the pro+ non-integrated mattress (P7924A), see the *pro+ Mattress Service Manual* (209197) for the mattress preventative maintenance.

For service and/or technical information other than that specified in this manual, including fuse replacement, circuit diagrams, and isolation of AC power, refer to the *Centrella Smart+ Bed Service Manual* (193588).

Do annual preventive maintenance procedures to make sure the **Centrella** Smart+ Bed operates as originally designed. The procedures include examinations of these:

- Overall condition
- Siderails
- Controls and motors
- Battery Backup
- Brakes and casters
- Scale system
- Head angle display
- Communication system
- Transport system
- Transport system batteries
- Mattress
- Accessories

## **BATTERIES**

The expected life of the batteries is 3 years.

Refer to the **Centrella** Smart+ Bed Service Manual (193588) for battery replacement procedures.

### **Bed Frame**

Replace the batteries if any of these conditions occur:

- The battery indicator does not come on within 3 minutes of the bed being connected to AC power.
- The battery indicator does not stop flashing (low condition) within 12 hours of the bed being connected to AC power.

### **IntelliDrive Transport System**

Contact your facility-authorized maintenance person or Hill-Rom Technical Support if any of the conditions below occur with the transport system. The batteries will need to be replaced.

- The transport system automatically shuts down power before the final battery charge indicator flashes.
- Successive transports of 4 hours or less cause the batteries to run critically low as indicated by a flashing battery indicator and a triple beep every two minutes.

After the batteries are replaced, charge them for a minimum of 20 hours before use.

## DECOMMISSIONING AND DISPOSAL INSTRUCTIONS

Customers should adhere to all federal, state, regional, and/or local laws and regulations as it pertains to the safe disposal of medical devices and accessories. If in doubt, the user of the device shall first contact Hill-Rom Technical Support for guidance on safe disposal protocols.

- In order to ensure the safe handling and disposal of this product, follow all relevant warnings provided in the service manual regarding possible causes of injury when decommissioning a bed.
  - Always make sure that the bed is unplugged before decommissioning.
- The bed and its accessories should be cleaned and disinfected, as described in the instructions for use, before any other decommissioning activities.
- If the decommissioned bed or accessory is still fit for use, Hill-Rom recommends donating the decommissioned bed and accessories to a charitable organization so that they can be reused.
- If the decommissioned bed or accessory is not fit for use, Hill-Rom recommends dismantling the bed in accordance with the instructions provided in the service manual. Hill-Rom recommends that all oil and hydraulic fluids are removed from the product before recycling or disposal, if applicable.
- Always check and comply with all local and national regulations and facility protocols when decommissioning a product.



Batteries should be recycled. Never dispose of batteries which contain substances that can be dangerous for the environment and health.



Other components, such as electronic components, plastics and metals, are recyclable in many local jurisdictions. Hill-Rom recommends recycling all components that can be recycled locally.

Components which cannot be recycled can be disposed of via standard waste disposal procedures.

## SERVICE CALLS



### WARNING:

**Warning**—Only facility-authorized persons or Hill-Rom service technicians should service the bed. Service done by unauthorized persons could cause injury or equipment damage.

When you call Hill-Rom about your unit, be prepared to give the serial number from the product identification label. You will find the serial numbers in these locations:

- Bed—as shown in the illustration
- Mattress—top cover



## TROUBLESHOOTING



### WARNING:

**Warning**—Only facility-authorized persons should service the bed. Service done by unauthorized persons could cause injury or equipment damage.

### POWER LOSS

A power loss can occur under these conditions:

- The bed power cord has been unplugged from the AC power outlet.
- A power outage has occurred.
- A bed fuse has blown.

During a power loss, the bed can operate on battery backup. See “Battery Charging Indicators and Battery Backup” on page 15.

When power is restored, the bed will resume operation at its previous state.

### NOTES:

- To make sure the On Battery Backup indicator operates correctly, do as follows:
  1. Unplug the bed, and make sure that the touchscreen shows “On Battery Backup”.
  2. Plug the bed in, and make sure that the touchscreen no longer shows “On Battery Backup”.
- The screen will dim after 10 seconds and then go off after 30 seconds of no activity.

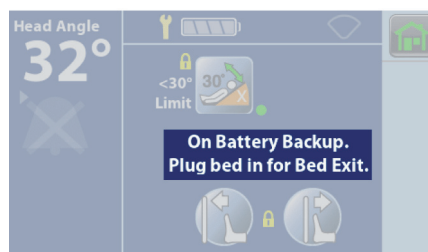

### THE BED DOES NOT LOWER

Make sure of these:

- The bed is plugged into AC power, **or** the battery is active.
- The Bed Down control is not locked out.
- There is nothing between the upper and the base frames.
- There is nothing between the **Obstacle Detect** sensors on the base frame.
- The base covers with **Obstacle Detect** sensors are installed correctly.
- The bed is not adjacent to a device that can cause electromagnetic (EM) interference with the **Obstacle Detect** System. See “Obstacle Detect System” on page 35.



## SPECIFICATIONS

### Model Identification

Model	Description
P7900	<b>Centrella</b> Smart+ Bed
P7920	<b>Centrella</b> core mattress
P7921	<b>Centrella</b> pro mattress
P7922	<b>Centrella</b> max mattress
P7923	<b>Centrella</b> pro+ mattress (integrated)
P7924	<b>Centrella</b> pro+ mattress (non-integrated)
P200898	HR/RR Monitoring System <sup>a</sup>
P00697905	<b>WatchCare</b> reader and antennas
P1200A	Hillrom <b>ReadyConnect</b> wall unit

a. Beds with the HR/RR Monitoring System are equipped with a sensor under the mattress on the head section.

### Bed Specifications

Feature	Dimension
Overall width <sup>a</sup>	40" (101.6 cm) or 43" (109.22 cm)
Overall length with foot extension <sup>a</sup>	
Maximum (foot section extended)	98.7" (251 cm)
Minimum (foot section retracted)	86.7" (220 cm)
Bed Height <sup>b</sup>	
Maximum	32.5" (83 cm)
Minimum	14.5" (37 cm)
Caster Size	5" (13 cm)
Total Weight (includes the Safe Working Load)	550 kg (1213 lb)
Head Section Inclination	0° to 65°
Thigh Section Inclination	0° to 30°
Foot section Inclination	0° to 25°
Trendelenburg Position (maximum)	15°
Reverse Trendelenburg Position (maximum)	15°
Safe Working Load—includes patient weight, mattress, and accessories	295 kg (650 lb)
Patient weight range	32 kg to 227 kg (70 lb to 500 lb)

a. Measured from the outermost points (bumpers).

b. Measured from the top of the seat section outer edge to the floor.

**Environmental Conditions for Use**

Condition	Range
Temperature	41°F to 95°F (5°C to 35°C)
Relative humidity	20% to 85%
Pressure	70 kPa to 106 kPa

**Environmental Conditions for Transport and Storage**

Condition	Range
Temperature	-20°F to 140°F (-29°C to 60°C)
Relative humidity	15% to 90%
Pressure	50 kPa to 106 kPa

**AC/Mains Power Requirements**

Condition	Range
Rated voltage	100-240 V AC
Input current rating	10 A
Frequency	50-60 Hz

**Auxiliary Outlet Power Specifications**

Fuse	Type
Receptacle	10 A outlet, electrically isolated from the bed's mains power (120 V)

There are no user accessible fuses. Refer to the **Centrella** Smart+ Bed *Service Manual (193588)* for fuse ratings and replacement procedures.

**Applied Parts (in accordance with IEC 60601-1)**

Applied parts	Applied parts
Siderail	Headboard
Footboard	Patient pendant
Sleep deck	Mattress

**Nurse Call Connection Requirements**

For information about the Nurse Call connection requirements, refer to the **SideCom** *Communication System and Design and Application Manual (DS059)*. Contact the Nurse Call manufacturer to make sure the Nurse Call system is compatible with the bed.

### Bed Classification and Standards

Classification	Standard
Technical and quality assurance standards	AAMI ES 60601-1 IEC 60601-1 IEC 60601-2-52 IEC 60601-2-49 IEC 60601-1-8 (for beds with HR and RR Monitoring System*) CAN/CSA-C22.2 No. 60601-1 ISO13485
Equipment classification per EN 60601-1	Class 1
Degree of protection against electric shock	Type B
Degree of protection against ingress of water	IPX4
Degree of protection against the presence of flammable anesthetic mixtures	Not for use with flammable anesthetics
Mode of operation	Non-continuous: 2 min on / 18 min off duty cycle
Sound level	<65 dBA
Application environments	Application Environment 1,2,3, and 5 per EN 60601-2-52

a. The IEC 60601-1-8 standard only applies to the Heart and Respiration Rate Monitoring System.

### Flammability Codes—United States and Canada

All recommended mattresses meet the applicable United States and Canadian flammability specifications (see the product's law label).

### Electromagnetic Compatibility Guidance



#### CAUTION:

This device meets all requirements for electromagnetic compatibility per IEC 60601-1-2. It is unlikely that the user will encounter problems with this device because of inadequate electromagnetic immunity. However, electromagnetic immunity is always relative, and standards are based on anticipated environments of use. If the user observes unusual device behavior, particularly if such behavior is intermittent and associated with nearby use of radio or TV transmitters, cell phones, security systems (e.g. electromagnetic anti-theft systems, and metal detectors), radio-frequency identification (RFID) readers, near-field communications (NFC) systems, wireless power transfer (WPT) or electro-surgical equipment (e.g. diathermy and electrocautery), this could be an indication of electromagnetic interference. If such behavior occurs, the user should try to move the interfering equipment further from this device.



**WARNING:**

**Warning**—Portable RF communications equipment (including peripherals such as antenna cables and external antennas) should be used no closer than 30 cm (12 inches) to any part of the Heart and Respiration Rate Monitoring System, including cables specified by Hill-Rom. Otherwise, degradation of the performance of this equipment could result.

The P7900 and HR and RR Monitoring System—

- **Warning**—The system should not be used adjacent to or stacked with other electrical equipment.
- **Warning**—Observe to make sure that the system and the stacked equipment operate as intended, if adjacent or stacked use is necessary.
- **Warning**—Observe to make sure the system operates properly when used near portable and mobile radio frequency (RF) communications equipment, as these can affect electrical equipment.
- **Warning**—Use of accessories, transducers, and cables other than those specified or provided by the manufacturer of this equipment could result in increased electromagnetic emissions or decreased electromagnetic immunity of this equipment and result in improper operation. See the *Centrella Bed Service Manual* (193588) for compatible component part numbers.

Medical equipment needs special precautions in regard to electromagnetic compatibility (EMC) and needs to be installed and put into service according to the EMC information supplied in the tables that follow.

<b>Guidance and Manufacturer's Declaration—Electromagnetic Emissions</b>		
The P7900 and HR and RR Monitoring System are intended for use in the electromagnetic environment specified below. The customer or the user should make sure they are used in such an environment.		
<b>Emissions Test</b>	<b>Compliance</b>	<b>Electromagnetic Environment—Guidance</b>
RF emissions CISPR 11	Group 1	The P7900 uses RF energy only for its internal functions. Therefore, its RF emissions are low and are not likely to cause any interference in nearby electronic equipment.  The P7900 is suitable for use in all establishments other than domestic establishments and those directly connected to the public low-voltage power supply network that supplies buildings used for domestic purposes.
RF Emissions CISPR 11	Class A	
Harmonic Emissions IEC 61000-3-2	Not applicable	
Voltage Fluctuations/ Flicker Emissions IEC 61000-3-3	Not applicable	

NOTE: The emissions characteristics of this equipment make it suitable for use in industrial areas and hospitals (CISPR 11 class A). If it is used in a residential environment (for which CISPR 11 class B is normally required) this equipment might not offer adequate protection to radio-frequency communication services. The user might need to take mitigation measures, such as relocating or reorienting the equipment.

## Electromagnetic Immunity Guidance

<b>Guidance and Manufacturer's Declaration - Electromagnetic Immunity</b>			
The P7900 and HR and RR Monitoring System are intended for use in the electromagnetic environment specified below. The customer or the user should make sure they are used in such an environment.			
<b>Immunity Test</b>	<b>IEC 60601 Test Level</b>	<b>Compliance Level</b>	<b>Electromagnetic Environment—Guidance</b>
Electrostatic Discharge (ESD) IEC 61000-4-2	± 8 kV Contact ± 2 kV, ± 4 kV, ± 8 kV, and ± 15 kV Air	± 8 kV Contact ± 2 kV, ± 4 kV, ± 8 kV, and ± 15 kV Air	Floors should be wood, concrete, or ceramic tile. If floors are covered with synthetic material, the relative humidity should be at least 30%.
Electrical Fast Transient/Burst IEC 61000-4-4	± 2 kV (100 kHz repetition frequency) for Power Supply Lines	± 2 kV (100 kHz repetition frequency) for Power Supply Lines	Mains power quality should be that of a typical hospital environment.
Surge IEC 61000-4-5	±0.5 kV, ± 1 kV Line(s) to Line(s) ±0.5 kV, ±1 kV, ± 2 kV Line(s) to Ground	±0.5 kV, ± 1 kV Line(s) to Line(s) ±0.5 kV, ±1 kV, ± 2 kV Line(s) to Ground	Mains power quality should be that of a typical hospital environment.
Voltage Dips IEC 61000-4-11	0% U <sub>T</sub> : 0.5 cycle At 0°, 45°, 90°, 135°, 180°, 225°, 270°, and 315°  0% U <sub>T</sub> : 1 cycle and 70% U <sub>T</sub> : 25/30 cycles  Single phase: at 0° (see note)	0% U <sub>T</sub> : 0.5 cycle At 0°, 45°, 90°, 135°, 180°, 225°, 270°, and 315°  0% U <sub>T</sub> : 1 cycle and 70% U <sub>T</sub> : 30 cycles  Single phase: at 0° (see note)	Mains power quality should be of a typical hospital environment. If the user of the P7900 requires continued operation during power mains interruption, it is recommended that the P7900 be powered from an uninterruptible power supply.
Voltage interruption IEC 61000-4-11	0% U <sub>T</sub> : 250/300 cycles	0% U <sub>T</sub> : 300 cycles	
Power Frequency Magnetic Fields IEC 61000-4-8	30 A/m 50 Hz and 60 Hz	30 A/m 50 Hz and 60 Hz	Power frequency magnetic fields should be at levels characteristic of a typical location in a typical hospital environment.
Proximity Magnetic Fields IEC 61000-4-39	30 kHz, CW, 8 A/m  134.2kHz, 50% Pulse at 2.1 kHz, 65 A/m  13.56MHz, 50% Pulse at 50 kHz, 7.5 A/m	30 kHz, CW, 8 A/m  134.2kHz, 50% Pulse at 2.1 kHz, 65 A/m  13.56MHz, 50% Pulse at 50 kHz, 7.5 A/m	
Conducted RF IEC 61000-4-6	3 V 0.15 MHz - 80 MHz 6 V in ISM bands between 0.15 MHz and 80 MHz 80% AM at 1 kHz	3 V 0.15 MHz - 80 MHz 6 V in ISM bands between 0.15 MHz and 80 MHz 80% AM at 1 kHz	Field strengths from fixed RF transmitters, as determined by an electromagnetic site survey <sup>6</sup> , should be less than the compliance level in each frequency range. Interference may occur in the vicinity of equipment marked with this symbol.  

<b>Guidance and Manufacturer's Declaration - Electromagnetic Immunity</b>			
The P7900 and HR and RR Monitoring System are intended for use in the electromagnetic environment specified below. The customer or the user should make sure they are used in such an environment.			
<b>Immunity Test</b>	<b>IEC 60601 Test Level</b>	<b>Compliance Level</b>	<b>Electromagnetic Environment—Guidance</b>
Radiated RF IEC 61000-4-3	3 V/m 80 MHz to 2.7 GHz 80% AM at 1 kHz	10 V/m 80 MHz to 2.7 GHz 80% AM at 1 kHz	
<b>NOTES:</b>			
<ul style="list-style-type: none"> <li>• These guidelines may not apply in all situations. Electromagnetic propagation is affected by absorption and reflection from structures, objects and people.</li> <li>• <math>U_T</math> is the AC mains voltage prior to application of the test level.</li> </ul>			

- a. Field strengths from fixed transmitters, such as base stations for radio (cellular/cordless) telephones and land mobile radios, amateur radio, AM and FM radio broadcast and TV broadcast cannot be predicted theoretically with accuracy. To assess the electromagnetic environment due to fixed RF transmitters, an electromagnetic site survey should be considered. If the measured field strength in the location in which the P7900 is used exceeds the applicable RF compliance level above, the P7900 should be observed to verify normal operation. If abnormal performance is observed, additional measures may be necessary, such as reorienting or relocating the P7900.

<b>IMMUNITY to Proximity Fields from Radio Frequency Wireless Communications Equipment</b>						
In addition to the Radiated RF IEC 61000-4-3 as shown in the table above, the P7900 and HR and RR Monitoring System have been tested as specified in the table below.						
Test Frequency (MHz)	Band (MHz)	Service	Modulation	Maximum Power (W)	Distance (m)	Immunity Test Level (V/m)
385	380-390	TETRA 400	50% PM, 18 Hz	1,8	0,3	27
450	430-470	GMRS 460, FRS 460	50% PM, 18Hz	2	0,3	28
710	704-787	LTE Band 13, 17	50% PM, 217 Hz	0,2	0,3	9
745						
780						
810	800-960	GSM 800/900 TETRA 800, iDEN 820, CDMA 850, LTE Band 5	50% PM, 18 Hz	2	0,3	28
870						
930						
1720	1700-1990	GSM 1800; CDMA 1900; GSM 1900; DECT; LTE Band 1,3, 4, 25; UMTS	50% PM, 217 Hz	2	0,3	28
1845						
1970						
2450	2400-2570	<b>Bluetooth</b> WLAN, 802.11 b/g/n, RFID 2450, LTE Band 7	50% PM, 217 Hz	2	0,3	28
5240	5100-5800	WLAN 802.11 a/n	50% PM, 217 Hz	0,2	0,3	9
5500						
5785						
<b>NOTES:</b>						
<ul style="list-style-type: none"> <li>For Frequencies above 1 GHz, the transmitting antenna distance was reduced to 1m as permitted by the IEC/EN60601-1-2 and UEC/EN 61000-4-3 Standards.</li> </ul>						
<ul style="list-style-type: none"> <li>As an alternative to FM modulation, 50% pulse modulation at 18Hz may be used because while it does not represent actual modulation, it would be worst case as permitted by the standard (Table 9 of IEC 60601-1-2: 2014).</li> </ul>						

<b>Recommended Separation Distances between Portable and Mobile RF Communications Equipment and the P7900 Model and HR and RR Monitoring System</b>			
The P7900 and HR and RR Monitoring System are intended for use in an electromagnetic environment in which radiated RF disturbances are controlled. The customer or the user of the P7900 can help prevent electromagnetic interference by maintaining a minimum distance between portable and mobile RF communications equipment (transmitters) and the P7900 as recommended below, according to the maximum output power of the communications equipment.			
<b>Rated maximum output power of transmitter, W</b>	<b>Separation distance according to frequency of transmitter, m</b>		
	150 kHz to 80 MHz <b><math>d = 1.2\sqrt{P}</math></b>	80 MHz to 800 MHz <b><math>d = 1.2\sqrt{P}</math></b>	800 MHz to 2.5 GHz <b><math>d = 2.33\sqrt{P}</math></b>
0.01	0.12	0.12	0.23
0.1	0.38	0.38	0.73
1	1.2	1.2	2.3
10	3.8	3.8	7.3
100	12	12	23
For transmitters rated at a maximum output power not listed above, the recommended separation distance <b>d</b> in meters (m) can be estimated using the equation applicable to the frequency of the transmitter, where P is the maximum output power rating of the transmitter in watts (W) according to the transmitter manufacturer. NOTE 1: At 80 MHz and 800 MHz, the separation distance for the higher frequency range applies. NOTE 2: These guidelines may not apply in all situations. Electromagnetic propagation is affected by absorption and reflection from structures, objects and people.			

### General Wireless Recommendations

The following are general best practice recommendations for establishing durable wireless connections between the Hillrom Radio and the customer's wireless network:

Received Signal Strength Indication (RSSI)	Hillrom highly recommends a primary RSSI Value of better than or equal to -67dBm and a secondary wireless signal of -70dBm or better over the coverage area.  For proper Tx/Rx balance, RSSI readings should apply when APs are transmitting at 25mW or less. The device radio transmits on average up to 25mW power, limited by Regulatory Domain restrictions. The AP signal strength and radio signal strength must be balanced, if not, dropped packets and loss of connectivity can result.
Signal to Noise Ratio (SNR)	≥15dB. High noise level may cause dropped packets.
Jitter	Packet-to-Packet jitter should be ≤400ms.
DTIM	Set DTIM value to 1 (Wireless Controller default) for best performance.
SSID/WLAN Settings	<ul style="list-style-type: none"> <li>• Enable Session Timeout = Disabled</li> <li>• Client Load Balancing = Disabled</li> <li>• Client Band Select = Disabled</li> </ul>
Spanning Tree Protocol (STP)	STP should be disabled for the Hillrom specific wireless VLAN/SSI.
Ports Open	<ul style="list-style-type: none"> <li>• Smart Sync</li> <li>• Smart Device Connectivity Gateway</li> </ul>



## Wireless Connectivity Specifications

The Wireless Connectivity module supports these security protocols:

### Standards

- Wired Equivalent Privacy (WEP)
- Wireless Protected Access (WPA)
- IEEE 802.11i (WPA2)

### Encryption

The Wireless Connectivity module supports these encryption protocols:

- Wired Equivalent Privacy (WEP, RC4 Algorithm)
- Temporal Key Integrity Protocol (TKIP, RC4 Algorithm)
- Advanced Encryption Standard (AES, Rijndael Algorithm)
- Encryption Key Provisioning Static (40-bit and 128-bit lengths)
- Pre-Shared (PSK)
- Dynamic 802.1X
- Encryption Options
  - Off
  - On
  - Auto
  - PSK
  - WPA-TKIP
  - WPA2-PSK
  - WPA2-AES
  - CCKM-TKIP
  - CCKM-AES
  - WPA-PSK-AES
  - WPA-AES

### Extensible Authentication Protocol Types (EAP Types)

- PEAP-MSCHAP
- PEAP-GTC

#### NOTE:

The current firmware for the **Centrella** Smart+ Beds WiFi interface does not support 802.11r fast transition authentication key management (AKM)—fast transition-pre-shared key (FT-PSK) or 802.1x-FT. Cisco/Meraki wireless local area networks (WLANs) on which **Centrella** Smart+ Beds will be connected that use 802.11r must have their AKM modified to Fast Transition: Adaptive. For other WiFi vendors, please refer to their documentation for adaptive, fast transition AKM strategies.

## Wireless System Characteristics

Characteristic	Description
Frequency Band—2.4 GHz	FCC: 2.4 GHz to 2.483 GHz ETSI: 2.4 GHz to 2.483 GHz MIC: 2.4 GHz to 2.495 GHz KC: 2.4 GHz to 2.483 GHz
Frequency Band—5GHz	FCC: 5.15 GHz to 5.35 GHz, 5.725 GHz to 5.825 GHz ETSI: 5.15 GHz to 5.35 GHz, 5.47 GHz to 5.725 GHz MIC: 5.15 GHz to 5.35 GHz, 5.47 GHz to 5.725 GHz (W56) KC: 5.15 GHz to 5.25 GHz, 5.725 GHz to 5.825 GHz
Modulation	BPSK @ 1, 6, 6.5, 7.2, and 9 Mbps QPSK @ 2, 12, 13, 14.4, 18, 19.5, and 21.7 Mbps CCK @ 5.5 and 11Mbps 16-QAM @ 24, 26, 28.9, 36, 39, and 43.3 Mbps 64-QAM @ 48, 52, 54, 57.8, 58.5, 65, and 72.2 Mbps
Network Standards	IEEE 802.11a, 802.11b, 802.11d, 802.11e, 802.11g, 802.11h, 802.11i, 802.11n
Data Rates Supported	802.11a (OFDM): 6, 9, 12, 18, 24, 36, 48, 54 Mbps 802.11b (DSSS, CCK): 1, 2, 5.5, 11 Mbps 802.11g (OFDM): 6, 9, 12, 18, 24, 36, 48, 54 Mbps 802.11n (OFDM, HT20, MCS 0-7): 6.5, 13, 19.5, 26, 39, 52, 58.5, 72.2 Mbps and 7.2, 14.4, 21.7, 28.9, 43.3, 57.8, 65 Mbps
Transmit Power Settings	802.11a: 6 Mbps 15 dBm, 54 Mbps 13 dBm (PER - 10%) 802.11b: 1 Mbps 16 dBm, 11 Mbps 16 dBm (PER - 10%) 802.11g: 6 Mbps 16 dBm, 54 Mbps 14 dBm (PER - 10%) 802.11n (2.4 GHz): MCS0 Mbps 16 dBm MCS7 Mbps 12 dBm 802.11n (5 GHz): MCS0 Mbps 15 dBm, MCS7 Mbps 12 dBm <b>Bluetooth:</b> 2 dBm (1.58 mW) (Class 2)

## WiFi and Bluetooth Radio Approval

Variscite Module—VS10R5MN5-MAEDCL1B	Texas Instruments Module—WL18 MODGI	FCC ID: Z64-WL18DBMOD IC ID: 4511-WL18DBMOD
-------------------------------------	-------------------------------------	--

## Regulatory Information

Changes and/or modifications not expressly approved by Hill-Rom Co., Inc. could void the user's authority to operate the equipment.

The module must be installed and used in accordance with the Hill-Rom user and installation instructions. Hill-Rom is not responsible for any radio or television interference caused by unauthorized modification of the devices included with the Hillrom module, or the substitution or attachment of connection cables and equipment other than that specified by Hill-Rom Co., Inc. The correction of interference caused by such unauthorized modification, substitution, or attachment is the responsibility of the user. Hill-Rom is not liable for any damage or violation of government regulations that may arise from the user failing to comply with these requirements.

## USA—Federal Communications Commission (FCC) Radiation Exposure Statement

The radiated output power of the module is below the FCC radio frequency exposure limits. The module must be used in such a manner that the potential for human contact during normal operation is minimized. To avoid the possibility to exceed the FCC radio frequency exposure limits, you should keep a distance of at least 8" (20 cm) between you (or any other person in the vicinity) and the antenna that is built into the wireless module.

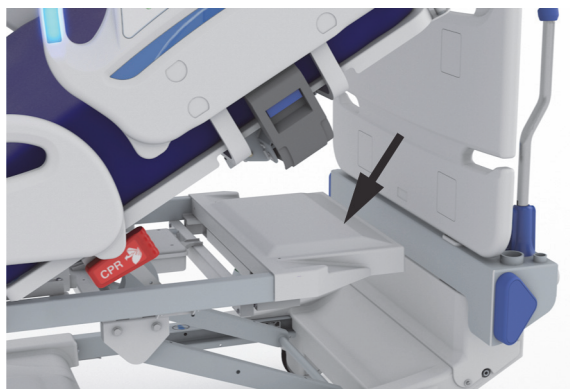

## Interference Statement for FCC

### NOTE:

"Harmful interference" is defined by the FCC as follows: Any emission, radiation or induction that endangers the functioning of a radio navigation service or of other safety services or seriously degrades, obstructs, or repeatedly interrupts a radiocommunications service operating in accordance with FCC rules.

These devices comply with Part 15 of the FCC Rules. Operation of the devices is subject to these two conditions: (1) the devices may not cause harmful interference, and (2) the devices must accept any interference that may cause unwanted operation.

This equipment has been tested and found to comply with the limits for a Class A digital device, pursuant to Part 15 of the FCC Rules. These limits are designed to supply reasonable protection against harmful interference in a residential installation. This equipment generates, uses, and can radiate radio frequency energy. If the equipment is not installed and used in accordance with the instructions, the equipment may cause harmful interference to radio communications. There is no guarantee, however, that such interference will not occur in a particular installation. If this equipment does cause harmful interference to radio or television reception (which can be determined by turning the equipment off and on), the user is encouraged to take one of these measures to try to correct the interference:

- Move this device.
- Increase the separation between the device and the receiver.
- Connect the device to an outlet on a circuit different from that of other electronics.
- Consult the dealer or an experienced radio technician for help.

### NOTE:

The module must be installed and used in strict accordance with the manufacturer's instructions as described in the user documentation that comes with the product. Any other installation or use will violate FCC Part 15 regulations. Modifications not expressly approved by Hill-Rom could void your authority to operate the equipment.

The module must not be co-located or operated in conjunction with any other antenna or transmitter.

## Canada—Industry Canada (IC)

### RF Radiation Hazard Warning

This device complies with RSS-247 of Industry Canada.

Operation is subject to these two conditions: (1) this device may not cause interference, and (2) this device must accept any interference, which include interference that may cause unwanted operation of this device.

The term "IC" before the equipment certification number only signifies that the Industry Canada technical specifications were met.

To prevent radio interference to the licensed service, this device is intended to be operated indoors and away from windows to provide maximum shielding. Equipment (or its transmit antenna) that is installed outdoors is subject to licensing.



**CAUTION:**

Exposure to Radio Frequency Radiation.

The installer of this radio equipment must make sure the antenna is located or pointed such that it does not emit an RF field in excess of Health Canada limits for the general population; consult Safety Code 6, obtainable from Health Canada's website <http://www.hc-sc.gc.ca/rpb>.

Using higher gain antennas and types of antennas not certified for use with this product is not allowed. The device shall not be co-located with another transmitter.

---

## DEPARTMENT IDENTIFICATION LABEL PLACEMENT

There are two places to place a department identification label, see below:



**NOTES:**

---



***Baxter***